



ESTB 1993

**ZUPPER**<sup>®</sup>  
TO BE YOUR PROUD TOOL

# WE BUILD WITH YOU

What we build can last for years. But what we do can last forever



**ZUPPER**<sup>®</sup>  
TO BE YOUR PROUD TOOL

**TAIZHOU JULI TOOLS CO.,LTD.**

ADD:Xuan Men Industrial Estate, Yuhuan,  
Taizhou, Zhejiang Province, 317608, China  
Tel:+86-576-87301677/ 87301678 Fax:+86-576-87301690  
Http://www.zuppertools.com E-mail:sales@juli-tools.com



Website



Catalogue for  
Plumbing tool



YouTube



2024-2025 | PLUMBING TOOL

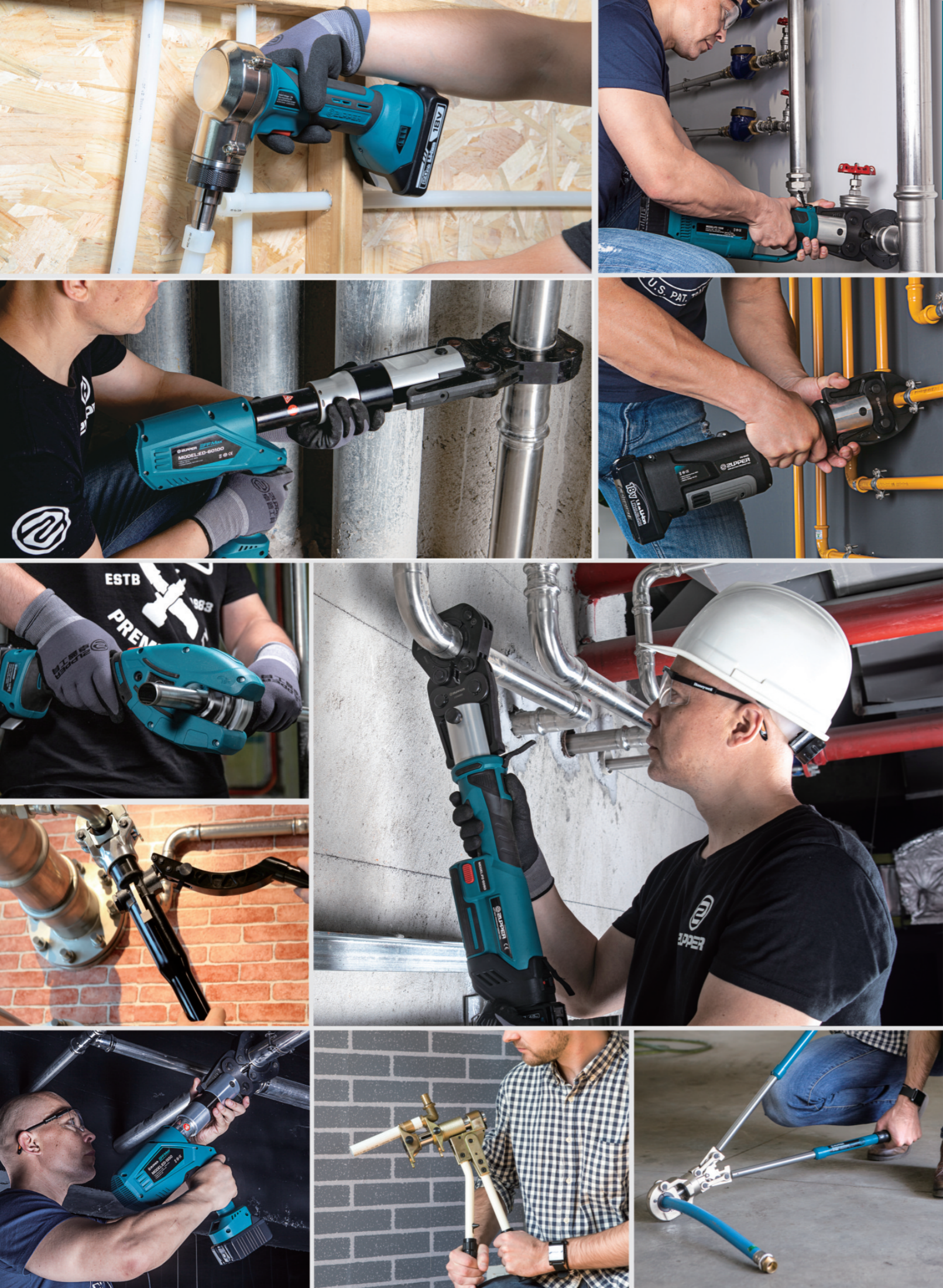

# HOW IT ALL BEGAN

## START FROM THE YEAR OF 1993

Since the company began from 1993, ZUPPER TOOL has experienced from "made in China" to "Created in China", We has become the leader of battery hydraulic tools in China more than 30 years

We build the tools for plumbing and heating installations last for years, but what we do can last forever. We manufacture best-in-class products by 350 strong highly trained team and sold over 100 countries.

We work continuously to improve the quality, efficiency and safety of our products to meet global market expectations and requirements. Accordingly many of our products are patented and comply with various international standards. ZUPPER products and you, together, WE BUILD.

ESTB

1993



# MORE THAN 30 YEARS OF EXPERIENCE

# IMPORTANT EVENTS

# OF ZUPPER TOOLS

From 1993 until now, ZUPPER TOOL has experienced from "made in China" to "Created in China", We has become the leader of hydraulic tools in China more than 30 years  
We build the electrical tools and tools for plumbing and heating installation last for years, but what we do can last forever.

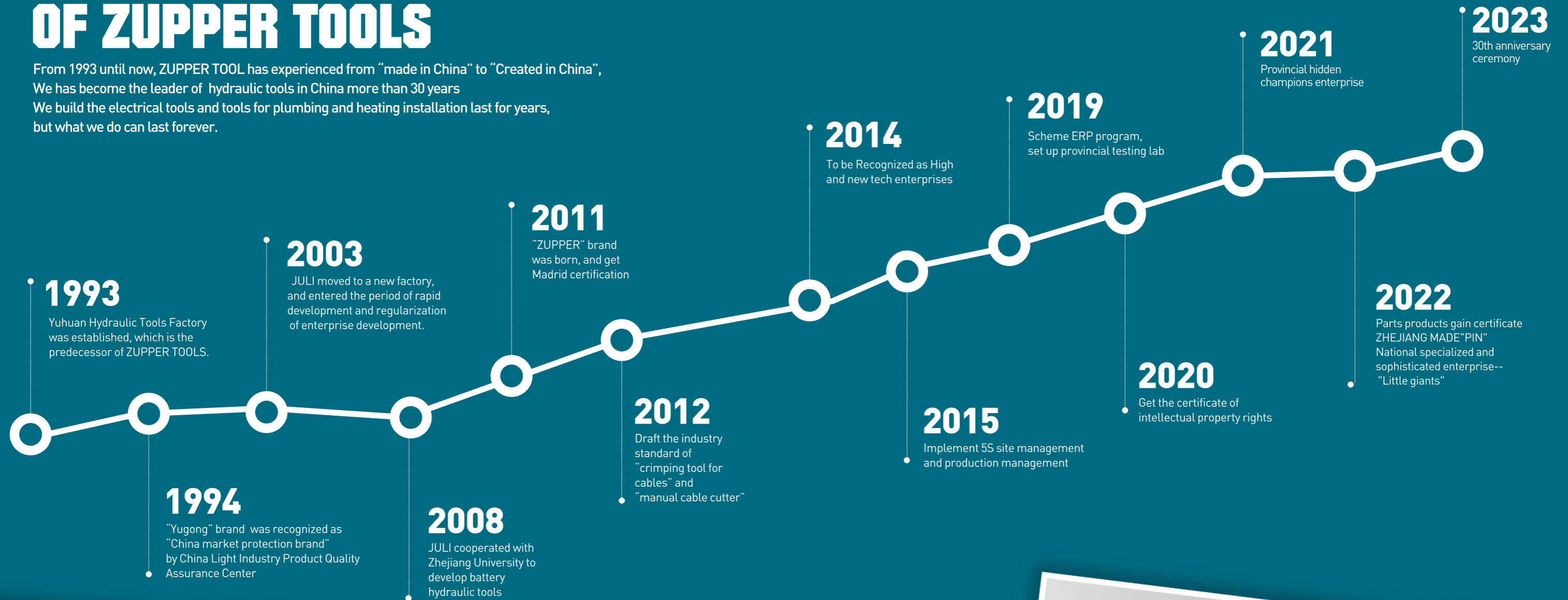

# WORLD LEADING PRODUCT INNOVATION

Continuous improvement and development for our tools is to ensure top quality, low costs and adequate availability. During more than 30 years, we have developed 8 generations of battery powered tools that take our leadership in the market. The durability and stability of the tools exceeds or is equal to some international brands in the market to become a more cost-effective industry choice.

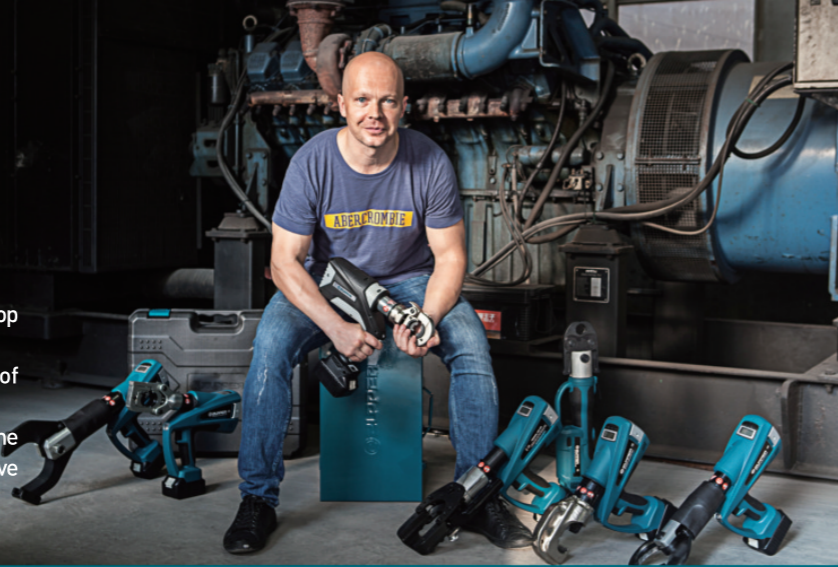

- 2008**: First generation EHT Series
- 2010**: Second generation EZ Series
- 2013**: Third generation BZ Series
- 2016**: Forth generation PZ/CZ press tool
- 2018**: Fifth generation EB/ED Series
- 2019**: Sixth generation PZ mini Series
- 2021**: Seventh generation PZ-3240
- 2022**: Cordless tube expanding tool, Cordless tubing cutter, Battery powered hydraulic pump
- 2023**: Battery mechanical press tool, Brushless battery press tool
- 2024**: Eighth generation SL Series

# CERTIFICATES FOR PRODUCT QUALITY AND MANAGEMENT

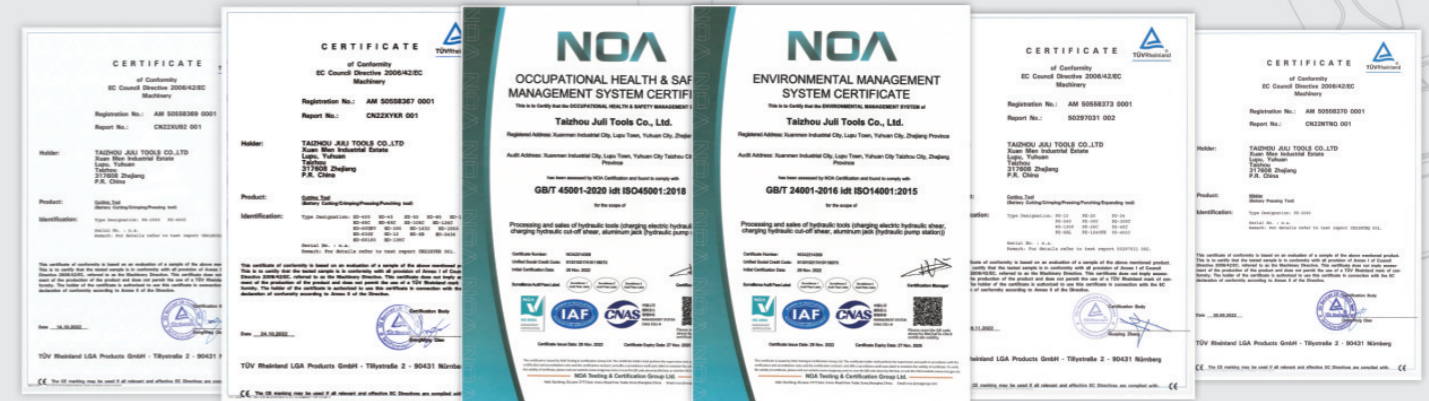

## ZUPPER for enhanced safety and optimized standards

For us, just meeting the standard is not enough, in terms of safety, efficiency and reliability. We are approved by ISO9001, ISO14001, ISO45001 certificates, and CE, UKCA, RoHS by TUV.



## More than 100 PATENTS

Including intention patent 22 items, Utility model patent 35 items. Our highly skilled development team works constantly on practical and innovative solutions. We designed and developed with safety, efficiency and durability as our core concepts.

ESTB 1993



## TOP QUALITY FROM PRECISION PRODUCTION

To ensure the stability and high quality of our products, we purchase raw materials and components that guarantee first-class quality. We have more than 300 processing modern equipment; the latest CNC machines guarantee precision manufacturing for all tool components. The most important part is the key parts and processes of the product are completed in the factory to ensure that each product of the world class level.



## TOP QUALITY FROM MULTIPLE DEPTH INSPECTION

We build Precision Hydraulic Tool Research Institute to test raw material and important components, the only one in Zhejiang Province, it includes spectrometer, three coordinate measuring instruments, Keyence 3D scanner, Salt spray tester, profile meter, Image measuring instrument and spring testing and so on.

ESTB 1993

# CONTENT

BATTERY POWERED PRESS TOOL ..... 10-39	
ELECTRICAL POWERED PRESS TOOL ..... 40-41	
HAND-OPERATED HYDRAULIC PRESS TOOL ..... 42-43	
BATTERY PUMP ..... 44-45	
CORDLESS TUBING CUTTER ..... 46	
CORDLESS TUBE EXPANDING TOOL ..... 47	
BATTERY POWERED AXIAL PRESS TOOL ..... 48-55	
MANUAL TOOL ..... 56-60	
BENDING TOOL ..... 61	
PRESS JAWS ..... 62-70	



# BLM-1930 COMPACT EFFICIENCY DURABLE



## New generation BLM series Brushless motor Battery Powered Press Tool



**NEW**

**BL  
MOTOR**

350° Rotating Head



LED indicator  
For illumination



Manual Retract if Need



LED indicator  
For showing tool status, warning

All Tools can be Controlled  
by One Trigger

**OLED Display**  
Show Press Cycles,  
Power, Errors Info

High Performance  
18v Li-ion Battery

**2  
YEARS**  
**30000  
CYCLES**  
**BLM SERIES**  
BATTERY POWERED  
PRESS TOOL



## BLM-1930 Battery Powered Press Tool

- Professional tool for the highest demands
- One-hand operation thanks to ergonomic design
- Compact measures with 350° rotatable head, suitable for tight work area
- **Brushless motor**  
with longer life time, more Run-time and maintenance-free
- **Updated PCB technology**  
waterproof, dustproof, metal scraps proof
- **Optional function**  
bluetooth, pressure sensor and wireless remote controller



COPPER PIPE



MULTI-LAYER COMPOSITE PIPE



PEX PIPE



STAINLESS STEEL PIPE



**2.4s**  
PER CYCLE TIME

**2  
YEARS**  
**30000  
CYCLES**  
**BLM SERIES**  
BATTERY POWERED  
PRESS TOOL

### Specifications

Capacity:	up to 35mm Stainless steel pipe, Copper pipe up to 40mm Plastic pipe, Multi-layer composite pipe	Battery:	18V Li-ion 2.0Ah
Output:	19kN	Battery Charger:	AC 100V-240V 50-60Hz
Stroke:	30mm	Charging Time:	Approx. 40mins
Oil capacity:	Approx. 60ml	Service Interval:	10000cycles
Pressing cycle time:	2-4s	Weight:	2.1kgs(tool with battery)
Pressing cycles/charge:	180cycles (DN 20 Stainless Steel)	Tool Size:	409x120x80mm
Model No.	Description	Weight (KGS)	Standard Pack
BLM-1930	BLM-1930 Battery Press Tool Kit without jaws	4.6	1set
Accessories	18V, 2.0 Ah Li-Ion Batteries	0.3	2pcs
	Charger	0.5	1pc
	Plastic case	1.7	1pc
	Sealing ring of cylinder:		1set
	Sealing ring of safety valve:		1set

## BLM-2430 Battery Powered Press Tool

- up to 35mm Stainless steel pipe, Copper pipe
  - up to 40mm Plastic pipe, Multi-layer composite pipe
- 24kN Powerful output  
MAX press  $\phi$ 35mm stainless steel pipe  
2.1KGS Portable and convenient



**2.4s**  
PER CYCLE TIME

**BL**  
MOTOR

**2**  
YEARS  
**30000**  
CYCLES  
**BLM SERIES**  
BATTERY POWERED  
PRESS TOOL

### Technical Data

Capacity:	up to 35mm Stainless steel pipe, Copper pipe up to 40mm Plastic pipe, Multi-layer composite pipe	Pressing cycles/charge:	180 cycles (DN20 Stainless Steel)
		Battery:	18V 2.0Ah Li-ion
		Charging voltage:	AC100-240V 50-60Hz
Rated pressure:	24kN	Charging time:	Approx.40mins
Rated power:	300W	Service interval:	10000cycles
Stroke:	30mm	Weight:	2.1kgs(tool with battery)
Pressing cycle time:	2.5-5s	Tool size:	409x120x80mm
Model No.	Description	Weight (KGS)	Standard Pack
BLM-2430	BLM-2430 Battery Press Tool kit without jaws	4.6	1set
	18V 2.0Ah Li-ion Batteries	0.3	2pcs
Accessories	Charger	0.5	1pc
	Plastic case	1.7	1pc
	Sealing ring		1set



**STABLE, RELIABLE, DURABLE  
LATEST TECHNOLOGY  
FOR PRESS TOOL**



# TO BE MORE SMART TO BE MORE SLIM



- Ergonomic design with light weight, easily work overhead and in tight spaces
- The indicator light, with green indicating completion of press cycle, and red indicating press error or tool malfunction
- Only 2-4S to finish one cycle press
- SERVICE INTERVAL 10000 cycles



350° rotating head



LED indicator  
For illumination

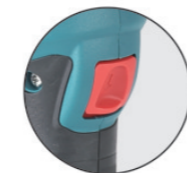

Manual Retract if Need

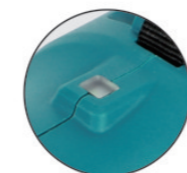

LED indicator  
For showing tool status,warning

All Tools can be Controlled  
by One Trigger

Anti-slip Handle

OLED Display  
Show Press Cycles,  
Power, Errors Info

Battery Lock

High Performance  
18v Li-ion Battery

## SL-1930 Battery Powered Press Tool

- up to 35mm Stainless steel pipe, Copper pipe
- up to 40mm Plastic pipe, Multi-layer composite pipe

The ZUPPER SL series with latest technology, updated structure and extended lifetime. It is slim and smart, really a good choice with in-line grip.



**2.4s**  
PER CYCLE TIME



### Specifications

Capacity:	up to 35mm Stainless steel pipe, Copper pipe	Battery:	18V Li-ion 2.0Ah
	up to 40mm Plastic pipe, Multi-layer composite pipe	Battery Charger:	AC 100V-240V 50-60Hz
Output:	19kN	Charging Time:	Approx. 40mins
Stroke:	30mm	Service Interval:	10000cycles
Oil capacity:	Approx. 35ml	Weight:	2.1kgs(tool with battery)
Pressing cycle time:	2-4S	Tool Size:	409×119×76mm
Pressing cycles/charge:	180cycles (DN 20 Stainless Steel)		

Model No.	Description	Weight (KGS)	Standard Pack
SL-1930	SL-1930 Battery Press Tool Kit without jaws	4.6	1set
	18V, 2.0 Ah Li-Ion Batteries	0.3	2pcs
	Charger	0.5	1pc
Accessories	Plastic case	1.7	1pc
	Sealing ring of cylinder:		1set
	Sealing ring of safety valve:		1set

## SL-2430 Battery Powered Press Tool

- up to 35mm Stainless steel pipe, Copper pipe
  - up to 40mm Plastic pipe, Multi-layer composite pipe
- 24kN Powerful output  
MAX press  $\Phi$ 35mm stainless steel pipe  
2.3KGS Portable and convenient



COPPER PIPE



MULTI-LAYER COMPOSITE PIPE



PEX PIPE



STAINLESS STEEL PIPE



**2.4s**  
PER CYCLE TIME

**2**  
YEARS  
**30000**  
CYCLES  
**SL SERIES**  
BATTERY POWERED  
PRESS TOOL

### Technical Data

Capacity:	up to 35mm Stainless steel pipe, Copper pipe up to 40mm Plastic pipe, Multi-layer composite pipe	Pressing cycles/charge:	180 cycles (DN20 Stainless Steel)
Rated pressure:	24kN	Battery:	18V 2.0Ah Li-ion
Rated power:	270W	Charging voltage:	AC100-240V 50-60Hz
Stroke:	30mm	Charging time:	Approx.40mins
Pressing cycle time:	2.5-5s	Service interval:	10000cycles
Model No.	Description	Weight (KGS)	Standard Pack
SL-2430	SL-2430 Battery Press Tool kit without jaws	4.6	1set
	18V 2.0Ah Li-ion Batteries	0.3	2pcs
Accessories	Charger	0.5	1pc
	Plastic case	1.7	1pc
	Sealing ring		1set



SMALLER, FASTER, LIGHTER  
**COMPACT MEASURES  
HUGE POWER**

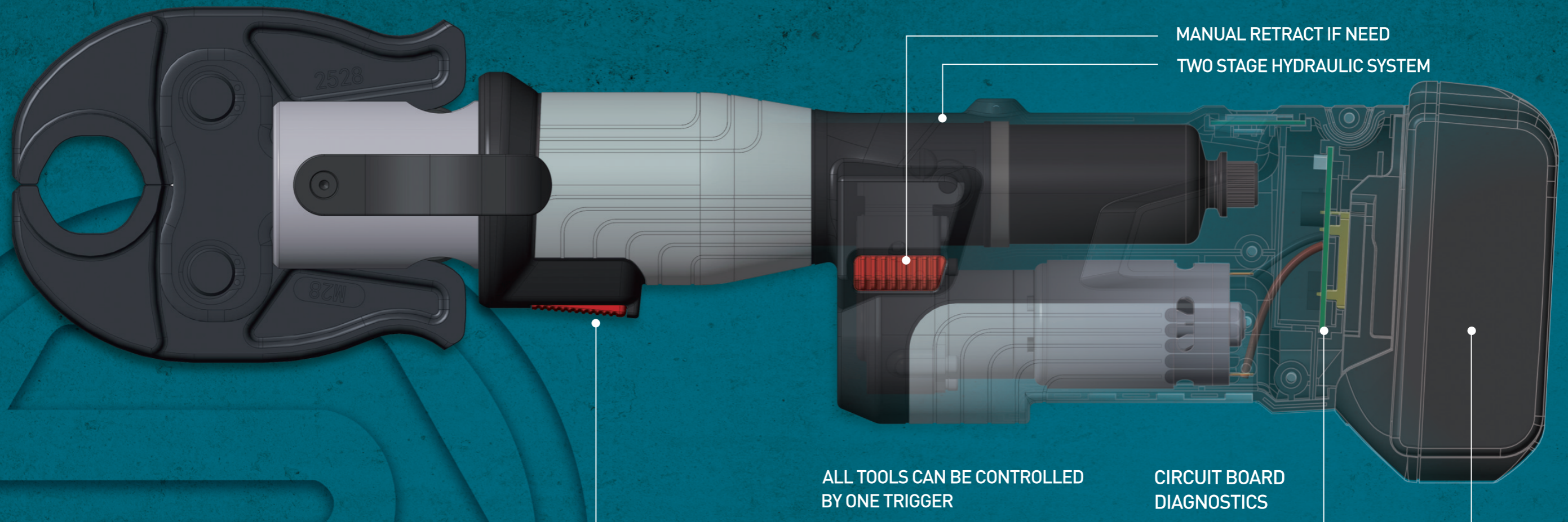

**THE RIGHT TOOL FOR YOUR NEEDS**

■ **CIRCUIT BOARD DIAGNOSTICS**

Alert you when the battery is low or the tool is too hot or cold

■ **OLED DISPLAY**

- Easy reading on
- Battery Percentage
- Pressing Times
- Fault Code
- Maintenance Note



■ **180° SWIVELLING BARREL**

Easy access to connections

■ **TWO STAGE HYDRAULIC SYSTEM**

Hydraulic Ram Output provides more force for reliable connection

■ **ERGONOMIC DESIGN**

With light weight and inline grip, easily work overhead and in tight spaces.

■ **SERVICE INTERVAL: 10000 Cycles**

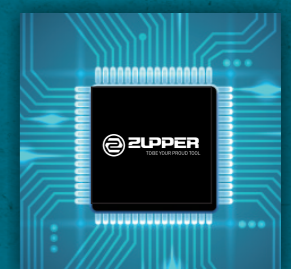

**CIRCUIT BOARD DIAGNOSTICS**  
Alert you when the battery is low or the tool is too hot or cold

## PZ-1930 Battery Powered Press Tool Precise pressing with lighter body

- up to 35mm Stainless steel pipe, Copper pipe
- up to 40mm Plastic pipe, Multi-layer composite pipe

The PZ-1930 is mini press tool with in-line grip, it is efficient and reliable way to join copper, stainless steel and PEX & Multi-layer Pipe.

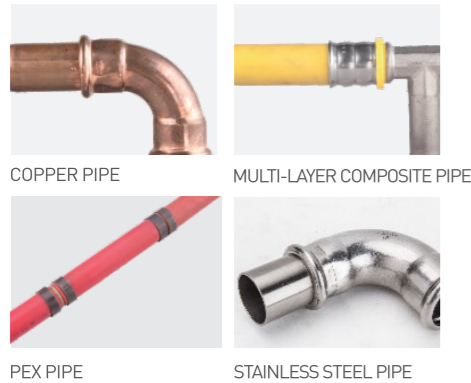

COPPER PIPE MULTI-LAYER COMPOSITE PIPE  
PEX PIPE STAINLESS STEEL PIPE



**2.4s**  
PER CYCLE TIME

**2**  
YEARS  
**30000**  
CYCLES  
**PZ SERIES**  
BATTERY POWERED  
PRESS TOOL

## PZ-2430 Battery Powered Press Tool 24kN Powerful output MAX press $\phi$ 35mm stainless steel pipe 2.2KGS Portable and convenient

- Quality guaranteed  
Core parts are general utilization and standardization
- Ergonomic design With light body
- OLED display shows battery percentage, press cycles, fault code, maintenance note



COPPER PIPE MULTI-LAYER COMPOSITE PIPE  
PEX PIPE STAINLESS STEEL PIPE



**2.4s**  
PER CYCLE TIME

**2**  
YEARS  
**30000**  
CYCLES  
**PZ SERIES**  
BATTERY POWERED  
PRESS TOOL

### Specifications

Capacity:	up to 35mm Stainless steel pipe, Copper pipe up to 40mm Plastic pipe, Multi-layer composite pipe	Battery:	18V Li-ion 2.0Ah
Output:	19kN	Battery Charger:	AC 100V-240V 50-60Hz
Stroke:	30mm	Charging Time:	Approx. 40mins
Oil capacity:	Approx. 60ml	Service Interval:	10000cycles
Pressing cycle time:	2-4s	Weight:	Approx. 2.0kgs (tool with battery)
Pressing cycles/charge:	180cycles (DN 20 Stainless Steel)	Tool Size:	Approx. 3.5kgs(tool with battery and jaw)

Model No.	Description	Weight (KGS)	Standard Pack
PZ-1930	PZ-1930 Battery Press Tool Kit without jaws	4.5	1set
ACCESSORIES	18V, 2.0 Ah Li-Ion Batteries	0.3	2pcs
	Charger	0.5	1pc
	Plastic case	1.7	1pc
	Sealing ring of cylinder:		1set
	Sealing ring of safety valve:		1set

### Specifications

Capacity:	up to 35mm Stainless steel pipe, Copper pipe up to 40mm Plastic pipe, Multi-layer composite pipe	Pressing cycles/charge:	180cycles( $\phi$ 20mm stainless steel pipe)
Rated pressure:	24kN	Battery:	18V 2.0Ah Li-ion
Rated power:	270W	Charging voltage:	AC100-240V 50-60Hz
Stroke:	30mm	Charging time:	Approx.40mins
Pressing cycle time:	2.5-5s	Service interval:	10000cycles
		Weight:	3.38kgs(tool with battery and jaw)
		Tool size:	362x122x76mm

Model No.	Description	Weight (KGS)	Standard Pack
PZ-2430	PZ-2430 Battery Press Tool kit without jaws	4.7Kgs	1set
Accessories	18V 2.0Ah Li-ion Batteries	0.3Kgs	2pcs
	Charger	0.5Kgs	1pc
	Plastic case	1.7Kgs	1pc
	Sealing ring		1set

## BZ-1930 Battery Powered Press Tool

improved ergonomic design and huge power in zipper hydraulic system

- Ergonomic designed with 30cm length and 2kgs lightweight, comfortable operation.
- The spare parts are made of high quality aviation aluminum
- Only 4-6S to finish one cycle press
- The tool includes two 18V, 2.0Ah Li-ion and one charger
- It is actuated by motor and controlled by MCU, with two stage hydraulic system.
- SERVICE INTERVAL 10000 cycles

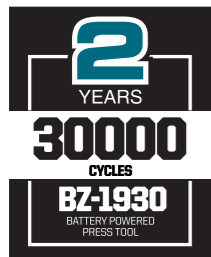

### Specifications

Capacity:	up to 35mm Stainless steel pipe, Copper pipe up to 40mm Plastic pipe, Multi-layer composite pipe	Battery:	18V Li-ion 2.0Ah
		Battery Charger:	AC 100V-240V 50-60Hz
		Charging Time:	Approx. 40mins
Output:	19kN	Service Interval:	10000cycles
Stroke:	30mm	Weight:	Approx.2.4kgs (tool with battery)
Oil capacity:	Approx. 60ml		Approx. 3.9kgs(tool with battery and jaw)
Pressing Cycle Time:	4-6S	Tool Size:	300x276x75mm
Pressing Cycles/charge:	180cycles (DN 20 Stainless Steel)		

Model No.	Description	Weight (KGS)	Standard Pack
BZ-1930	BZ-1930 Battery Press Tool Kit without jaws	6.20	1set
ACCESSORIES	18V, 2.0Ah Li-Ion Batteries	0.3	2pcs
	Charger	0.5	1pc
	Plastic case	2.90	1pc
	Sealing ring of cylinder:		1set
	Sealing ring of safety valve:		1set



## PZ-3240 Battery Powered Press Tool THE MOST DURABLE INTELLIGENT PRESS TOOL

✓ **LONGER WARRANTY**

2years or 40000cycles

✓ **180° SWIVELLING BARREL**

Easy access to connections

✓ **OPTIONAL EXTENDED FUNCTIONS**

Brushless motor /Pressure sensor /Bluetooth

- **OLED DISPLAY**  
Press cycle,Version Number, Maintenance note, Battery percentage,Fault code Rest available press cycles before next maintenance



All tools can be controlled by one trigger



LED Light

Manual Retract

High Performance 18V Li-ion Battery

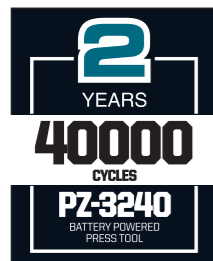

Kit includes:  
One press tool,Two 4.0Ah batteries,One charger, and carrying case.(Press jaws at optional)



COPPER PIPE

MULTI-LAYER COMPOSITE PIPE

PEX PIPE

STAINLESS STEEL PIPE

### Specifications

Capacity:	up to 54mm Stainless steel pipe	Pressing cycles/charge:	350cycles(DN 20 Stainless Steel)
	up to 108mm Plastic,Multi-layer composite and Copper pipes	Battery:	18V Li-ion 4.0Ah
Output:	32kN	Charging time:	Approx.80mins
Stroke:	40mm	Charging voltage:	AC 100V-240V 50-60Hz
Pressing cycle time:	3-6s(depends on the dia of pipe)	Service interval:	10000cycles
Tool Size:	495x89x123mm	Weight:	4.1kgs(tool with battery)
			6.2kgs(tool with battery and jaw)

## ED-5050 Battery Powered Press Tool For thick stainless steel, copper

- Designed with matching press jaws
- Cylinder is made of steel, Longer span life
- Two stage hydraulic system, high-efficiency
- OLED Display shows battery percentage, pressing times,fault code, maintenance note.



**3s**  
PER CYCLE TIME

## PZ-5050 Battery Powered Press Tool For thick stainless steel, copper

- Cylinder is made of high strength steel,longer span life
- Aerometal ram with matching press jaws,suit for thick pipe connections
- New design conform to ergonomics and optimized position of centre of gravity
- 180° swivelling barrel,easy access to connections
- Warranty 2years or 30,000cycles
- Brushless motor is optional,suit for inflammable and explosive field(professional test before using)
- Pressure sensor and Bluetooth wireless communication technology is optional



**3s**  
PER CYCLE TIME

Specifications	ED-5050	PZ-5050
Capacity:	up to 54mm Stainless steel pipe	up to 54mm Stainless steel pipe
	up to 108mm Plastic,Multi-layer composite and Copper pipes	up to 108mm Plastic,Multi-layer composite and Copper pipes
Rated pressure:	50kN	50kN
Stroke:	50mm	50mm
Time/work:	3-6s(depend on the dia of pipe)	3-6s(depend on the dia of pipe)
Cycles/charger:	180cycles	180cycles
Battery:	18V Li-ion 4.0Ah	18V Li-ion 4.0Ah
Charging voltage:	AC 100V-240V 50-60Hz	AC 100V-240V 50-60Hz
Charging time:	Approx.80mins	Approx.80mins
Service Interval:	10000cycles	10000cycles
Weight:	4.7kgs(with battery)	4.9kgs(with battery)

### Battery Press Tool Kit

	ED-5050	Weight(kgs)	PZ-5050	Weight(kgs)
ACCESSORRIES	Battery, 18V, 4.0Ah Li-Ion	0.6kgs	Battery, 18V, 4.0Ah Li-Ion	0.6kgs
	Charger	0.5kgs	Charger	0.5kgs
	Plastic case	4.1kgs	Plastic case	4.1kgs

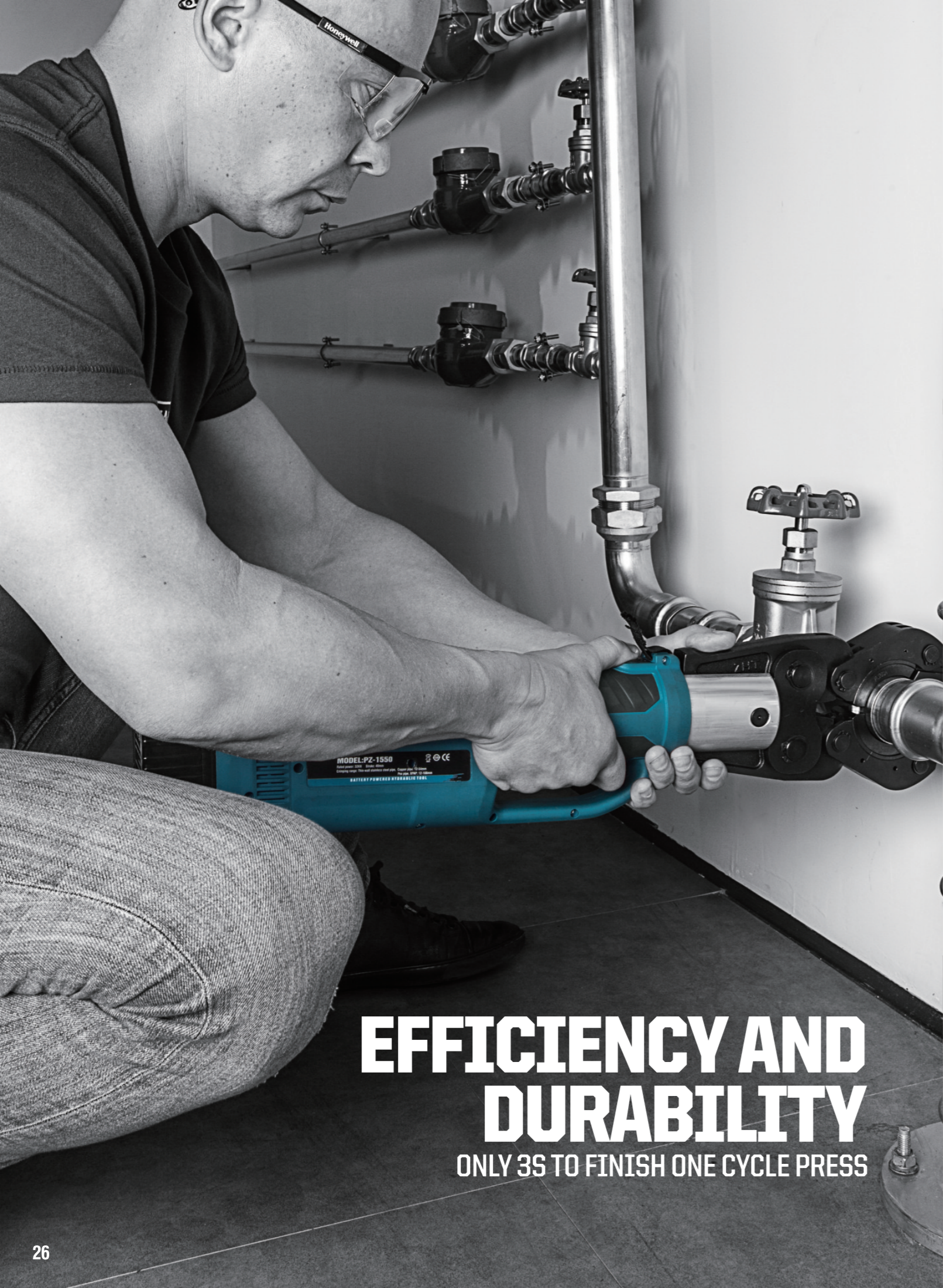

**EFFICIENCY AND DURABILITY**  
ONLY 3S TO FINISH ONE CYCLE PRESS

**PZ-1550**  
**Battery Powered Press Tool**  
**Efficiency and Durability**

- Battery press tool with in-line grip.
- Only 3-4.5S to finish one cycle press
- The tool comes standard with two 18v,4.0Ah Lion-batteries and one charger. It can achieve over 350 cycles per charger.
- Motor drivers, Micro-computer control system, OLED screen and double valve hydraulic system.



COPPER PIPE



MULTI-LAYER COMPOSITE PIPE



PEX PIPE



STAINLESS STEEL PIPE



**3s**  
PER CYCLE TIME

**2**  
YEARS

**30000**  
CYCLES

**PZ-1550**  
BATTERY POWERED PRESS TOOL

**Specifications**

Capacity:	up to 54mm Stainless steel pipe	Battery:	18V Li-ion 4.0Ah
	up to 108mm Plastic, Multi-layer composite and Copper pipes	Battery Charger:	AC 100-240V
Output:	32kN	Charging Time:	Approx. 80mins
Stroke:	40mm	Service Interval:	10000cycles
Cycle Time:	Approx. 3-4.5 seconds	Weight:	Approx.3.9kgs (tool with battery)
Oil capacity:	115ml		Approx.6.1kgs(tool with battery and jaw)
		Tool Size:	466x126x82mm

**PZ-1550 Battery Press Tool Kit**

MODEL NO.	DESCRIPTION	Weight(kgs)
PZ-1550	PZ-1550 Battery Press Tool Kit without jaws	9.20
	Battery, 18V, 4.0Ah Li-Ion	0.60
ACCESSORRIES	Charger	0.50
	Plastic case	4.20

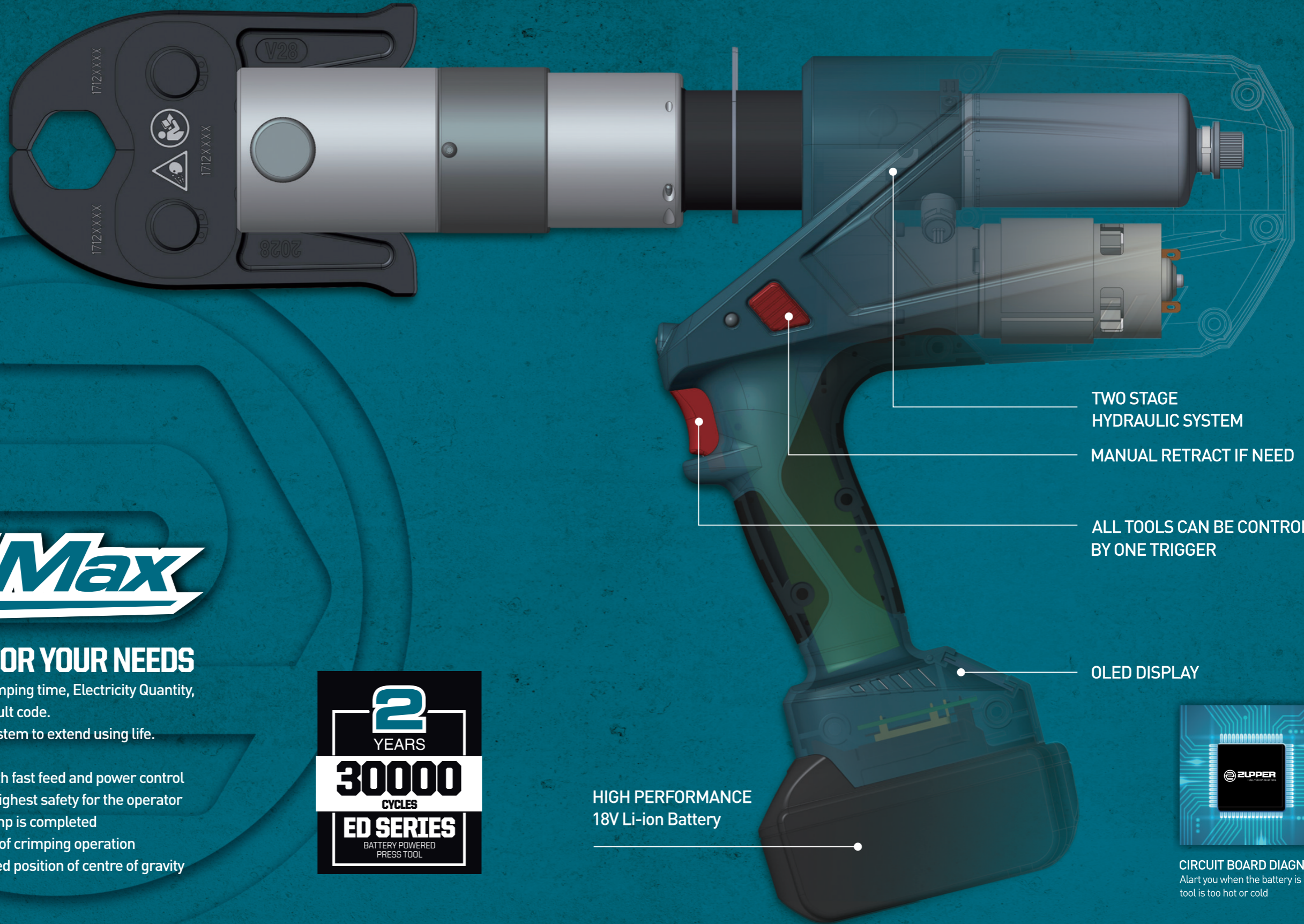

TWO STAGE  
HYDRAULIC SYSTEM

MANUAL RETRACT IF NEED

ALL TOOLS CAN BE CONTROLLED  
BY ONE TRIGGER

OLED DISPLAY

HIGH PERFORMANCE  
18V Li-ion Battery

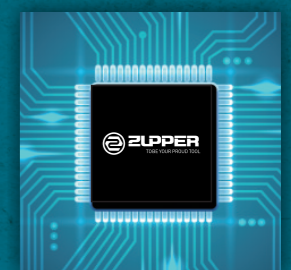

**CIRCUIT BOARD DIAGNOSTICS**  
Alert you when the battery is low or the  
tool is too hot or cold

# EFFMax

## THE RIGHT TOOL FOR YOUR NEEDS

- OLED Data Display to show crimping time, Electricity Quantity, maintenance reminding and fault code.
- Air Cooling Heat dissipation System to extend using life.
- Press head rotates 310°
- Two stage hydraulic system with fast feed and power control
- Quick motor stop guarantees highest safety for the operator
- Automatic retraction when crimp is completed
- Electronic control and monitor of crimping operation
- Ergonomic design and optimized position of centre of gravity

**2**  
YEARS

**30000**  
CYCLES

**ED SERIES**  
BATTERY POWERED  
PRESS TOOL



**THE FASTEST,  
MOST RELIABLE**



**ED-1550  
Battery Powered Press Tool  
Faster & Reliable**

The ED-1550 gives another option for a fast and reliable way to join copper, stainless steel and PEX pipe. The tool comes standard with two 18V, 4.0Ah Li-ion batteries and one charger, motor drives, Micro-computer control system, OLED screen and double valve hydraulic system, it can achieve over 350 cycles per charge.



COPPER PIPE



MULTI-LAYER COMPOSITE PIPE



PEX PIPE



STAINLESS STEEL PIPE

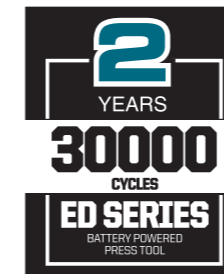

**3.8s**  
PER CYCLE TIME



BATTERY POWERED PRESS TOOL

**Specifications**

Capacity:	up to 54mm Stainless steel pipe	Battery:	18V Li-ion 4.0Ah
	up to 108mm Plastic, Multi-layer composite and Copper pipes	Battery Charger:	AC 100-240V
Output:	32kN	Charging Time:	Approx. 80mins
Stroke:	40mm	Service Interval:	10000cycles
Cycle Time:	Approx. 3-8 seconds	Weight:	Approx. 3.8kgs (tool with battery)
Oil capacity:	115ml		Approx. 6.0kgs (tool with battery and jaw)
		Tool Size:	394x326x84mm

**ED-1550 Battery Press Tool Kit**

MODEL NO.	DESCRIPTION	Weight(kgs)
ED-1550	ED-1550 Battery Press Tool Kit without jaws	9.0
	Battery, 18V, 4.0Ah Li-Ion	0.6
ACCESSORRIES	Charger	0.5
	Plastic case	4.1

**HH-60100**  
**Electrical Powered Press Tool**  
For big size from 60-108mm  
stainless steel pipe

- Designed with matching press jaws
- Cylinder is made of steel, Longer span life
- Two stage hydraulic system, high-efficiency
- OLED Display shows battery percentage, pressing times, fault code, maintenance note.

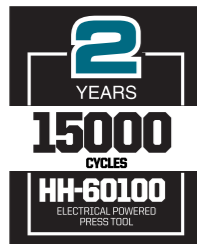

**ED-60100**  
**Battery Powered Press Tool**  
For big size from 60-108mm  
stainless steel pipe

- Designed with matching press jaws
- Cylinder is made of steel, Longer span life
- Two stage hydraulic system, high-efficiency
- OLED Display shows battery percentage, pressing times, fault code, maintenance note.

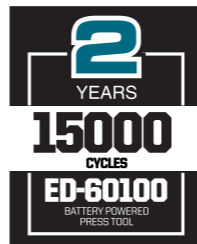

Specifications	HH-60100	ED-60100
Capacity:	up to 108mm Stainless steel pipe and Copper pipe	
Rated pressure:	65kN	65kN
Stroke:	80mm	80mm
Time/work:	10-25s(depend on the dia of pipe)	10-25s(depend on the dia of pipe)
Cycles/charger:		50cycles
Battery:		18V/5.0Ah
Battery Charger:		AC 100V-240V;50-60Hz
Charging Time:		Approx.100mins
Service Interval:	10,000cycles	10,000cycles
Weight:		

Battery Press Tool Kit				
	HH-60100	Weight(kgs)	ED-60100	Weight(kgs)
ACCESSORIES			Battery, 18V, 5.0Ah Li-Ion	0.6
			Charger	0.5
	Plastic case	6.1	Plastic case	6.1

**BRUSHLESS MOTOR**  
**LONGER MOTOR LIFE, MORE POWER,**  
**MORE RUN-TIME**

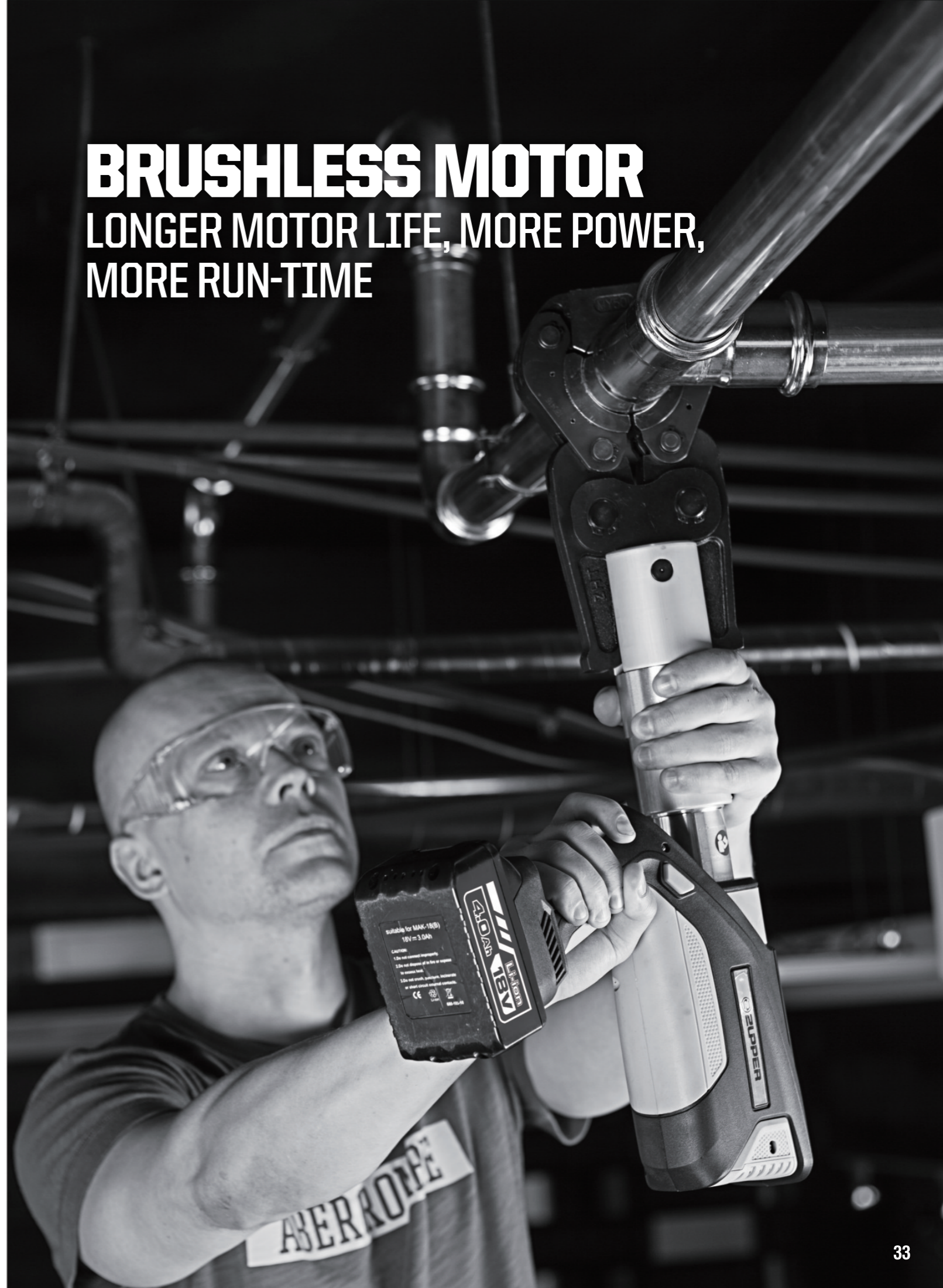

# NEW TECHNOLOGY OF EB SERIES BRUSHLESS MOTOR

No carbon brush, durability and reliability



Download on the App Store



GET IT ON Google Play

1. Download the ZUPPER Link APP from Apple Store or Google Play
2. Open the APP and sign in using your credentials or create a new account
3. Follow on-screen instructions to register your tool



**ONE TRIGGER**  
All tools can be controlled by one trigger



**OLED**  
OLED display shows the times of crimping, electricity quantity, maintenance reminder and fault code, etc.



**BRUSHLESS MOTOR**  
High-performance brushless motor drive technology.

# BL MOTOR

## BRUSHLESS MOTORS ARE DRIVING REVOLUTIONARY PERFORMANCE

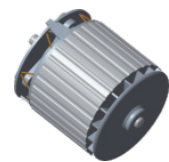

**LONGER MOTOR LIFE**

Longer life and maintenance-free thanks to brushless technology



**MORE POWER**

No carbon brush. When the motor is running, there is no power loss by friction and reduce the heat generated by the motor.

**+30%**

**MORE RUN-TIME**

Heat generated by Brushless motor is small. Compared to the brush motor, the brushless motor will do more work in the same full charge of the battery pack



**EXTENSIVE APPLICATION**

No carbon brush, the motor does not produce sparks at work, it is more suitable used in combustible place

## EB-1550 EB-32100 Battery Powered Press Tool New Technology Brushless Motor

- 3-6S to finish one cycle
- Automatic retraction when press is completed
- Two stage hydraulic system
- An ergonomic design and optimized position of center of gravity to provide increased feel and usability
- Micro computer control system



### Bluetooth® Bluetooth And Pressure Sensor

Thanks to new implemented Bluetooth technology, device-related data can be requested via the ZUPPER APP. The ZUPPER EB Series include BLUETOOTH as basic configuration, you can choose pressure sensor as optional.

### ZUPPER Check-APP

- Data transfer between press tool and APP
- See the location of where your ZUPPER Link enabled tool was last seen.
- Check the pressure by pressure sensor to differentiate the pressure normal or not.
- APP shows the pressure data counter to check and analyze the pressure easily.



Technical Data	EB-1550	EB-32100
Capacity:	up to 54mm Stainless steel pipe	up to 54mm Stainless steel pipe
	up to 108mm Plastic, Multi-layer composite and Copper pipes	up to 108mm Plastic, Multi-layer composite and Copper pipes
Output:	32kN	32kN
Stroke:	40mm	40/60/100mm (adjustable)
Cycle time:	3-6s (depends on diameter of pipe)	3-6s (depends on diameter of pipe)
Oil capacity:	115ml	250ml
Pressing cycles/charge	360 cycles (DN20 stainless steel)	360 cycles (DN20 stainless steel)
Battery:	18V Li-ion 4.0Ah	18V Li-ion 4.0Ah
Charger:	AC 100V-240V 50-60Hz	AC 100V-240V 50-60Hz
Charging time:	Approx. 80mins	Approx. 80mins
Service Interval:	10000 cycles	10000 cycles
Weight:	3.8kgs (tool with battery)	
	6.0kgs (tool with battery and jaw)	
Tool Size:	400x318x86mm	525x318x86mm

Accessories				
	EB-1550	Weight(kgs)	EB-32100	Weight(kgs)
Accessories:	Battery Press Tool Kit without jaws:	9.0	Battery Press Tool Kit without jaws:	
	18V Li-ion 4.0Ah	0.6	18V Li-ion 4.0Ah	0.6
	Charger	0.5	Charger	0.5
	Plastic case	4.1	Plastic case	4.1

Kit includes: EB-1550 battery press tool, Two 4.0Ah Batteries, One Charger and Carrying case



# RSW HIGH PERFORMANCE

SYSTEM UPGRADE, RETRACT STOP FOR POSITION CONTROL.  
EFFICIENCY AND SAVE TIME ON EVERY JOB.

## BZ-1550 Battery Powered Press Tool 220V Lasting Power Supply High performance, Save time

- Battery press tool with gun type grip.
- Jaws are made of high strength forging steel.
- LED light for low or no-light environment
- LCD data display can show pressing times, electricity quantity and maintenance reminding information
- The tool comes standard with two 18v,4.0Ah Lion-batteries and one charger. It can achieve over 300 cycles per charger.
- Motor drivers, Micro-computer control system, and double valve hydraulic system.

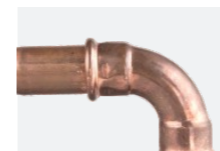

COPPER PIPE



MULTI-LAYER COMPOSITE PIPE



PEX PIPE



STAINLESS STEEL PIPE



**3.6s**  
PER CYCLE TIME



### Specifications

Capacity:	up to 54mm Stainless steel pipe up to 108mm Plastic, Multi-layer composite and Copper pipes	Battery:	18V Li-ion 4.0Ah
Output:	32kN	Charger:	AC 100V-240V 50-60Hz
Stroke:	40mm	Charging time:	Approx.80mins
Cycle time:	3-6s(depends on diameter of pipe)	Service Interval:	10000cycles
Pressing cycles/charge	350cycles(DN20 stainless steel)	Weight:	4.5kgs(tool with battery) 6.7kgs(tool with battery and jaw)
		Tool Size:	375x329x85mm

### Accessories:

MODEL NO.	DESCRIPTION	Weight(kgs)
BZ-1550	BZ-1550 Battery Press Tool Kit without jaws	9.65
	18V Li-ion 4.0Ah	0.6
ACCESSORIES	Charger	0.5
	Plastic case	4.1

Kit includes: BZ-1550 Press Tool, Two 4.0Ah batteries, One charger and carrying case

## MP-1930 Battery Powered Mechanical Press Tool

- up to 35mm Stainless steel pipe, Copper pipe
- up to 40mm Plastic pipe, Multi-layer composite pipe

The MP-1930 is the newest addition of press tool with mechanical system, it is faster and efficient way to join metal pipe and plastic pipe

- The tool is easier to do maintenance
- Enclosed screw structure prevents sand and dust
- Brushless motor with longer motor life and more Run-time
- Screw Drive with high efficient, press more fast
- Ergonomic design, comfortable operation
- ONE KEY control switch, automatically completes press cycles
- The indicator light, with green indicating completion of press cycle, and red indicating press error or tool malfunction

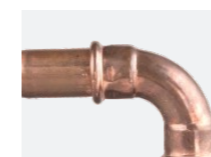

COPPER PIPE



MULTI-LAYER COMPOSITE PIPE



PEX PIPE



STAINLESS STEEL PIPE



**BL**  
MOTOR

**2**  
YEARS  
**20000**  
CYCLES

**MP-1930**  
BATTERY POWERED MECHANICAL  
PRESS TOOL

**2s**  
PER CYCLE TIME

SMALLER, FASTER, LIGHTER  
**COMPACT MEASURES  
HUGE POWER**

### Specifications

Capacity:	up to 35mm Stainless steel pipe, Copper pipe	Battery:	18V Li-ion 2.0Ah
	up to 40mm Plastic pipe, Multi-layer composite pipe	Battery Charger:	AC 100V-240V 50-60Hz
Output:	19kN	Charging Time:	Approx. 40mins
Stroke:	30mm	Weight:	Approx. 2.4kgs (tool with battery)
Pressing Cycle Time:	2S	Tool Size:	400x119x76mm

Model No.	Description	Weight (KGS)	Standard Pack
MP-1930	MP-1930 Battery Press Tool Kit without jaws	4.9	1set
ACCESSORIES	18V, 2.0 Ah Li-Ion Batteries	0.3	2pcs
	Charger	0.5	1pc
	Plastic case	1.7	1pc

## CZ-1550 Electric Powered Press Tool

- Only 3S to finish one cycle press
- Press jaw with piston, to avoid maloperation
- Anti-slip handle and an optimized center of gravity for easier carry.
- Motor drives, Micro-computer control system and double valve hydraulic system.

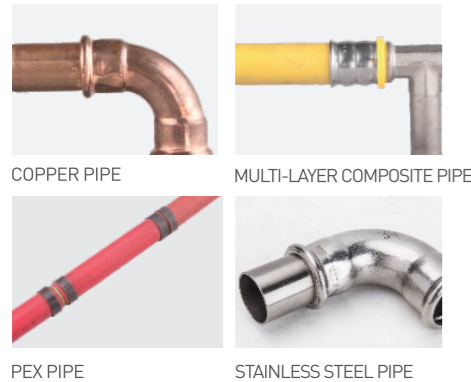
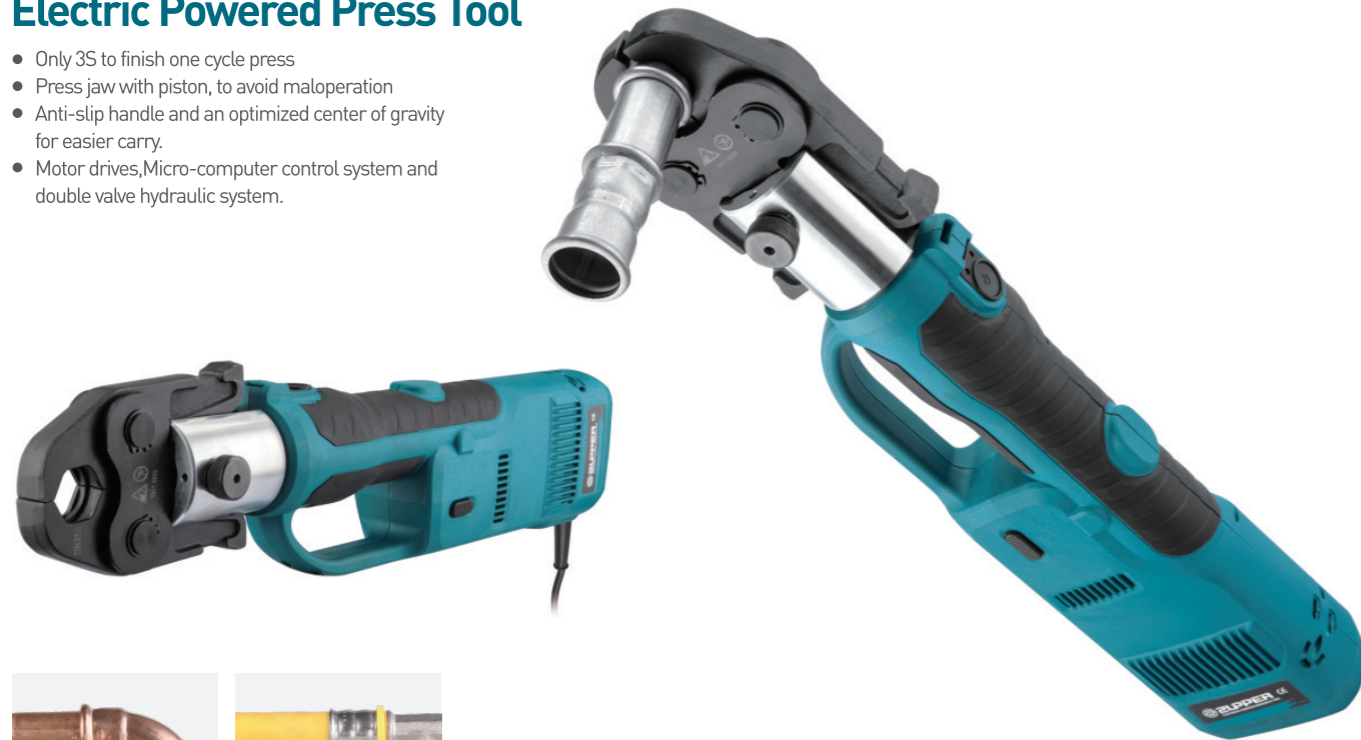

COPPER PIPE MULTI-LAYER COMPOSITE PIPE  
PEX PIPE STAINLESS STEEL PIPE

**2 YEARS**  
**30000 CYCLES**  
**CZ-1550**  
ELECTRICAL POWERED PRESS TOOL

**3.6s**  
PER CYCLE TIME



Specifications			
Capacity:	up to 54mm Stainless steel pipe	Rated Power:	490W
	up to 108mm Plastic, Multi-layer composite and Copper pipes	Voltage:	AC220V 50/60HZ (or AC 110V 50/60HZ)
Output:	32kN	Weight:	4.1kgs(without jaw)
Stroke:	40mm	Tool Size:	456 x 81 x 130mm
Cycle time:	3S(DN25)	Hydraulic oil:	Shell Tellus S2V HV15 130ml

Accessories:		
MODEL NO.	DESCRIPTION	Weight(kgs)
CZ-1550	CZ-1550 Press Tool Kit without jaws	8.15
	Plastic case	3.2

## HH-1550 Electric Powered Press Tool

520W High power  
220V lasting power supply,  
Reliable and Stable

- Only 3S to finish one cycle press
- Press jaw with piston, to avoid maloperation.
- Anti-slip handle and an optimized center of gravity for easier carry.
- Motor drives, Micro-computer control system and double valve hydraulic system.



COPPER PIPE MULTI-LAYER COMPOSITE PIPE  
PEX PIPE STAINLESS STEEL PIPE

**2 YEARS**  
**30000 CYCLES**  
**HH-1550**  
ELECTRICAL POWERED PRESS TOOL

**3.6s**  
PER CYCLE TIME



Specifications			
Capacity:	up to 54mm Stainless steel pipe	Rated Power:	520W
	up to 108mm Plastic, Multi-layer composite and Copper pipes	Voltage:	AC220V 50/60HZ (or AC 110V 50/60HZ)
Output:	32kN	Service Interval:	10000cycles
Stroke:	40mm	Weight:	4kgs(without jaw)
Cycle time:	2.6-6S	Tool Size:	422x328x82mm
		Hydraulic oil:	Shell Tellus S2V HV15 240ml

HH-1550 Press Tool Kit		
MODEL NO.	DESCRIPTION	Weight(kgs)
HH-1550	HH-1550 Press Tool Kit without jaws	7.2
	Plastic case	3.2



**HZ-1632** Hand-operated Hydraulic Press Tool

- With interchangeable dies
- 350° rotating head
- Two stage hydraulic system with fast feed and power stroke
- Light weight due to high quality aluminum housing
- Automatic retraction when crimping is completed
- With safety valve to prevent pressure overload.

Technical data	
Press range:	Φ16-32mm
Rated press force:	60kN
Rated work pressure:	63Mpa
Stroke:	17mm
Length:	460mm
Weight:	3.3kgs
Package:	Metal box

**HT-1930** Hand-operated Hydraulic Press Tool

- 350° rotating head
- Two stage hydraulic system with fast feed and power stroke
- Light weight due to high quality aluminum housing
- Automatic retraction when crimping is completed
- With safety valve to prevent pressure overload.

Technical data	
Press range:	12-35mm Stainless steel pipe 12-35mm(1/2"-1 3/8") Copper pipe 16-40mm PEX&Multi-layer composite pipe
Rated pressure:	19kN
Stroke:	30mm
Oil capacity:	48ml
Tool size:	385x63.5x231mm
Weight:	1.6kg(without jaws)

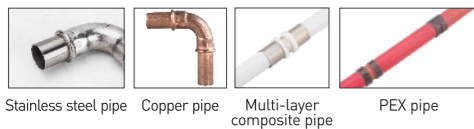

**HZ-1550** Hand-operated Hydraulic Press Tool

- Forged jaws with high strength, sturdy and durable
- 350° rotating head
- Two stage hydraulic system with fast feed and power stroke
- Light weight due to high quality aluminum housing
- Automatic retraction when crimping is completed
- With safety valve to prevent pressure overload.

Technical data	
Press range:	12-54mm(1/2"-2") for stainless steel pipe 12-108mm(1/2"-4") for PEX,Multi-layer and composite copper pipe
Rated press force:	32kN
Rated work pressure:	33Mpa
Stroke:	40mm
Package:	Metal box

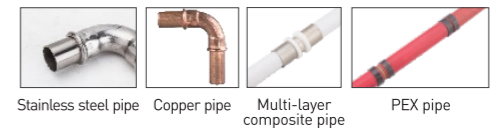
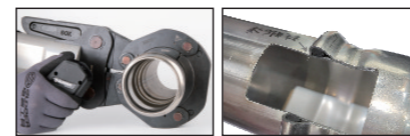

**FHT-60100** Hydraulic Press Head

For big size from 60-108mm stainless steel pipe

Technical data	
Press range:	60-108mm(2-4") for stainless steel pipe and copper pipe
Rated work pressure:	700bar(70MPa)
Stroke:	80mm
Oil capacity:	80ml
Tool size:	515x280x84mm
Weight:	9.3kgs(without jaw)
Package:	Metal box

**FHT-3240** Hydraulic Press Head

- Forged jaws with high strength, sturdy and durable
- Hand pump, foot pump and electrical pump optional

Technical data	
Press range:	12-54mm(1/2"-2") for stainless steel pipe 12-108mm(1/2"-4") for PEX,Multi-layer composite and copper pipe
Rated press force:	32kN
Rated work pressure:	52Mpa
Stroke:	40mm
Package:	Metal box

# EB-700

## Battery Powered Hydraulic Pump

- Lightweight and portable design for outdoor work
- OLED display show Pressure value, Maintenance note, Battery percentage, Working cycles ect.
- Automatic retraction when operation is complete
- Manual retract if need
- Electronic sensor pressure control
- High performance 18V Li-ion battery
- Operates for crimping, cutting and punching heads
- All tools and hydraulic hose with couplers, easy and quick to connect



**2 YEARS**  
**20000 CYCLES**  
**EB-700**  
BATTERY POWERED HYDRAULIC PUMP



1.5m Hydraulic hose

1.5m Remote controller  
(Wireless remote control at optional)

Carrying strap

Comfort Backpack

ALL TOOLS CAN BE CONTROLLED BY ONE TRIGGER



**MAGNETIC SUCTION CONTROLLER**  
can magnetize on the pump body or metal body



**OIL LEVEL MIRROR**  
convenient to observe the oil level



**OLED DISPLAY**  
Display pressure value, Maintenance note, Battery percentage, Working cycles ect.



**COUPLER**  
360° rotation  
Quick connect



**CONNECT CONTROLLER**

**MANUAL RETRACT IF NEED**  
Ensure safety operation



Specifications	
Oil Capacity:	Approx. 700ml
Pressure:	700bar(70Mpa)
Power:	490W
Voltage:	18.0V DC
Weight:	5.9kgs(with battery)
Tool size:	338x172x266mm
Battery:	5.0Ah Li-ion battery
Charging time:	100mins
Operation mode:	Remote control at 1.5 meters, or wireless remote control at 25 meters
Accessories	
Battery:	2pcs
Charger:	1pc
Strap:	1pc
Backpack:	1pc
Wireless control optional:	1pc with 1.5m wire
Oil tube:	1pc 1.5m





## MC-1228 Cordless Tubing Cutter

For Stainless steel pipe, Copper pipe and uncoated carbon steel pipe from  $\phi$ 12-28mm

- The light weight tool is only 2.9KGS, easy for one handed operation.
- Convenience and fast, 9S cut off  $\phi$ 20 Stainless steel pipe.
- Without burr and iron dust, clean after cutting.
- Auto-adjust dia from 12mm to 28mm.
- Built in LED light, to find the cutting position precisely.
- Easy to do pipe line maintenance in narrow space.



**9s** Cut Off 20mm Stainless steel pipe

**150** More than cuts per charge



**1** YEAR  
**10000** CYCLES  
MC-1228  
CORDLESS TUBING CUTTER



### Specifications

Cutting range:	$\leq 1.5\text{mm}$ $\phi$ 12-28mm
Voltage/capacity	18V/2.0Ah
Charging Time	Approx. 40mins
Charging Voltage	AC100V-240V; 50-60Hz
Weight	2.9kgs(with battery)
Cycle time	9s( $\phi$ 20mm Stainless steel pipe)
Cyles/charger	150cycles( $\phi$ 20mm Stainless steel pipe)
Tool Size	385x76x128mm

## ME-1225 Cordless Tube Expanding Tool

Quick & Easy Connections for PEX-a material

- Faster to connect PEX ring to PEX-a pipe
- Compact and portable, weight 2.45KGS with battery, easy for one handed operation
- More than 70 expansions per charge

### Expanding heads Cycles of expansions

16x1.8/2.2	4-6 cycles
20x1.9/2.0	6-8 cycles
25x2.3	8-12 cycles
32x2.9	22-25 cycles

### Suit for various projects



Auto-rotating head makes uniform expansion



### Expanding heads



**1** YEAR  
**10000** CYCLES  
ME-1225  
CORDLESS TUBE EXPANDING TOOL



### Specifications

Max expanding dia. and wall thickness range:	$\leq 25 \times 3.5\text{mm}$ , $\leq 32 \times 2.9\text{mm}$
Voltage/capacity:	18V/2.0Ah
Charging Time:	Approx. 40mins
Charging Voltage:	AC100V-240V; 50-60Hz
Weight:	2.45kgs(with battery)
Tool Size:	193x94x270mm
Standard expanding heads:	16x1.8/2.2mm, 20x1.9/2.0mm, 25x2.3mm

## BLM-1622 Battery Powered Axial Press Tool

For A/C Lock sleeve connection

- Ergonomic design, with light weight, easily work overhead and in tight spaces
- The indicator light, with green indicating completion of press cycle, and red indicating press error or tool malfunction
- Brushless motor, with longer life time, more Run-time and maintenance-free
- Updated PCB technology, waterproof, dustproof, metal scraps proof
- Optional pressure sensor and wireless remote controller



### Specifications

Output:	16kN
Stroke:	22mm
Suitable material:	Aluminum / Copper / Steel
Max connecting range:	Outer dia.16mm
Service interval:	10000cycles
Voltage of battery:	DC 18V,2.0Ah
Battery Charger:	AC 100V-240V 50-60Hz
Charging time:	Approx.40mins
Weight:	2.4kgs(with battery without jaw)
Tool size:	462x132x80mm

### Accessories:

Battery:	2pcs
Charger:	1pc
Sealing ring of cylinder:	1set
Sealing ring of safety valve:	1set



## BLM-1240PE Battery Powered Axial Press & Expand Tool

For axial press & expand Pex and Multi-layer composite pipe

### Specifications

Output:	18kN
Stroke:	39mm
Expanding/Connecting range:	φ16-32mm
Service interval:	10000cycles
Voltage of battery:	DC 18V,2.0Ah
Connecting cycle time	Approx. 2.5-5S
Charging voltage:	AC 100V-240V ;50-60Hz
Charging time:	Approx.40mins
Weight:	3.7kgs
Tool size:	373x252x97mm

### Accessories:

Battery:	2pcs
Charger:	1pc
Sealing ring of cylinder:	1set
Sealing ring of safety valve:	1set
Connecting jaws:	φ16-20mm、φ25-32mm
Expanding dies:	Pex pipe :φ16x2.2、φ20x2.8、φ25x3.5、φ32x4.4
PAP pipe(optional) :	φ16.2x2.6、φ20x2.9、φ25x3.7、φ32x4.7

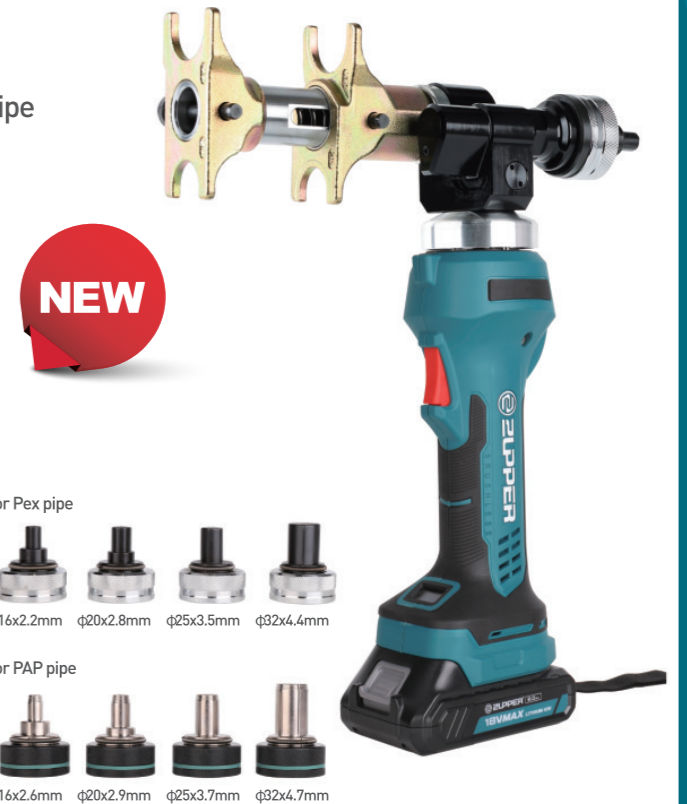

## BLM-1240 Battery Powered Axial Press Tool

For axial press Pex and Multi-layer composite pipe

### Specifications

Output:	18kN
Stroke:	39mm
Connecting range:	φ16-32mm
Service interval:	10000cycles
Voltage of battery:	DC 18V,2.0Ah
Connecting cycle time	Approx. 2.5-5s
Charging voltage:	AC 100V-240V ;50-60Hz
Charging time:	Approx.40mins
Weight:	3.2kgs
Tool size:	362x216x80mm

### Accessories:

Battery:	2pcs
Charger:	1pc
Sealing ring of cylinder:	1set
Sealing ring of safety valve:	1set
Connecting jaws:	φ16x2.2-20x2.8、φ25x3.5-32x4.4



## BLM-2620 Battery Powered Axial Press Tool

For axial press air conditioner pipe  
Be used in air conditioner, heating, refrigeration system

### Specifications

Rated pressure:	26kN
Connecting range:	φ6.35-28.6mm copper pipe
Charging voltage:	AC 100V-240V ;50-60Hz
Charging time:	Approx.40mins
Oil capacity:	Approx.60ml
Stroke:	20mm
Service interval:	10000cycles
Voltage of battery:	DC 18V,2.0Ah
Ambient temperature:	-10°C-40°C
Weight:	3.2kgs(with battery with jaw)
Tool size:	358x130x80mm

### Accessories:

Connecting jaws(optional):	6.35、9.52、12.7、15.88、19.05、 22.2、25.4、28.6mm (Integral type)
Battery:	2 pcs
Charger:	1 pc
Sealing ring of cylinder:	1 set
Sealing ring of safety valve:	1 set



## BLM-4523 Battery Powered Axial Press Tool

For axial press air conditioner pipe  
Be used in air conditioner, heating, refrigeration system

### Specifications

Rated pressure:	45kN
Stroke:	23mm
Connecting range:	φ6.35-38.1mm copper pipe
Oil capacity:	Approx.60ml
Ambient temperature:	-10°C-40°C
Service interval:	10000cycles
Voltage of battery:	DC 18V,2.0Ah
Charging voltage:	AC 100V-240V ;50-60Hz
Charging time:	Approx.40mins
Weight:	4.4kgs(with battery with jaw)
Tool size:	383x155x80mm

### Accessories:

Connecting jaws(optional):	6.35、9.52、12.7、15.88、19.05、22.2、 25.4、28.6、31.8、34.9、38.1mm
Battery:	2 pcs
Charger:	1 pc
Sealing ring of cylinder:	1 set
Sealing ring of safety valve:	1 set



## SL-1622 Battery Powered Axial Press Tool

For A/C Lock sleeve connection

- Ergonomic design,with light weight, easily work overhead and in tight spaces
- The indicator light, with green indicating completion of press cycle, and red indicating press error or tool malfunction
- Only 2-4S to finish one cycle press
- SERVICE INTERVAL 10000 cycles



### Specifications

Output:	16kN
Stroke:	22mm
Suitable material:	Aluminum / Copper /Steel
Max connecting range:	Outer dia.16mm
Service interval:	10000cycles
Voltage of battery:	DC 18V,2.0Ah
Battery Charger:	AC 100V-240V 50-60Hz
Charging time:	Approx.40mins
Weight:	2.4kgs(with battery without jaw)
Tool size:	463x132x76mm

### Accessories:

Battery:	2pcs
Charger:	1pc
Sealing ring of cylinder:	1set
Sealing ring of safety valve:	1set



## SL-1240PE Battery Powered Axial Press & Expand Tool

For axial press & expand Pex and Multi-layer composite pipe

Specifications	
Output:	18kN
Stroke:	39mm
Expanding/Connecting range:	φ16-32mm
Service interval:	10000cycles
Voltage of battery:	DC 18V,2.0Ah
Connecting cycle time	Approx. 2.5-5S
Charging voltage:	AC 100V~240V ;50~60Hz
Charging time:	Approx.40mins
Weight:	3.7kgs
Tool size:	373x252x97mm
Accessories:	
Battery:	2pcs
Charger:	1pc
Sealing ring of cylinder:	1set
Sealing ring of safety valve:	1set
Connecting jaws: φ16-20mm、φ25-32mm	
Expanding dies:	
Pex pipe :φ16x2.2、φ20x2.8、φ25x3.5、φ32x4.4	
PAP pipe(optional) :φ16.2x2.6、φ20x2.9、φ25x3.7、φ32x4.7	



## SL-1240 Battery Powered Axial Press Tool

For axial press Pex and Multi-layer composite pipe

Specifications	
Output:	18kN
Stroke:	39mm
Connecting range:	φ16-32mm
Service interval:	10000cycles
Voltage of battery:	DC 18V,2.0Ah
Connecting cycle time	Approx. 2.5-5s
Charging voltage:	AC 100V~240V ;50~60Hz
Charging time:	Approx.40mins
Weight:	3.3kgs
Tool size:	372x229x76mm
Accessories:	
Battery:	2pcs
Charger:	1pc
Sealing ring of cylinder:	1set
Sealing ring of safety valve:	1set
Connecting jaws:	φ16x2.2-20x2.8、φ25x3.5-32x4.4



## SL-2620 Battery Powered Axial Press Tool

For axial press air conditioner pipe  
Be used in air conditioner, heating, refrigeration system

Specifications	
Rated pressure:	26kN
Connecting range:	φ6.35-28.6mm copper pipe
Charging voltage:	AC 100V~240V ;50~60Hz
Charging time:	Approx.40mins
Oil capacity:	Approx.35ml
Stroke:	20mm
Service interval:	10000cycles
Voltage of battery:	DC 18V,2.0Ah
Ambient temperature:	-10°C~40°C
Weight:	3.2kgs(with battery with jaw)
Tool size:	331x130x76mm
Accessories:	
Connecting jaws(optional):	6.35、9.52、12.7、15.88、19.05、22.2、25.4、28.6mm (Integral type)
Battery:	2 pcs
Charger:	1 pc
Sealing ring of cylinder:	1 set
Sealing ring of safety valve:	1 set



## SL-4523 Battery Powered Axial Press Tool

For axial press air conditioner pipe  
Be used in air conditioner, heating, refrigeration system

Specifications	
Rated pressure:	45kN
Stroke:	23mm
Connecting range:	Φ6.35-38.1mm copper pipe
Oil capacity:	Approx.35ml
Ambient temperature:	-10°C~40°C
Service interval:	10000cycles
Voltage of battery:	DC 18V,2.0Ah
Charging voltage:	AC 100V~240V ;50~60Hz
Charging time:	Approx.40mins
Weight:	4.4kgs(with battery with jaw)
Tool size:	347x155x76mm
Accessories:	
Connecting jaws(optional):	6.35, 9.52, 12.7, 15.88, 19.05, 22.2, 25.4, 28.6, 31.8, 34.9, 38.1mm
Battery:	2 pcs
Charger:	1 pc
Sealing ring of cylinder:	1 set
Sealing ring of safety valve:	1 set



## PZ-1240PE

### Battery Powered Axial Press & Expand Tool

For axial press & expand Pex and Multi-layer composite pipe

#### Specifications

Output:	18kN
Stroke:	39mm
Expanding/Connecting range:	φ16-32mm
Service interval:	10000cycles
Voltage of battery:	DC 18V,2.0Ah
Connecting cycle time	Approx. 2.5-5S
Charging voltage:	AC 100V~240V ;50~60Hz
Charging time:	Approx.40mins
Weight:	3.7kgs
Tool size:	373x252x97mm

#### Accessories:

Battery:	2pcs
Charger:	1pc
Sealing ring of cylinder:	1set
Sealing ring of safety valve:	1set
Connecting jaws: φ16-20mm、φ25-32mm	
Expanding dies:	
Pex pipe :φ16x2.2、φ20x2.8、φ25x3.5、φ32x4.4	
PAP pipe(optional) :φ16.2x2.6、φ20x2.9、φ25x3.7、φ32x4.7	



## PZ-1240

### Battery Powered Axial Press Tool

For axial press Pex and Multi-layer composite pipe

#### Specifications

Output:	18kN
Stroke:	39mm
Connecting range:	φ16-32mm
Service interval:	10000cycles
Voltage of battery:	DC 18V,2.0Ah
Connecting cycle time	Approx. 2.5-5s
Charging voltage:	AC 100V~240V ;50~60Hz
Charging time:	Approx.40mins
Weight:	3.3kgs
Tool size:	372x229x76mm

#### Accessories:

Battery:	2pcs
Charger:	1pc
Sealing ring of cylinder:	1set
Sealing ring of safety valve:	1set
Connecting jaws:	φ16x2.2-20x2.8、φ25x3.5-32x4.4



## PZ-2620

### Battery Powered Axial Press Tool

For axial press air conditioner pipe  
Be used in air conditioner,heating,refrigeration system

#### Specifications

Rated pressure:	26kN
Connecting range:	φ6.35-28.6mm copper pipe
Charging voltage:	AC 100V~240V ;50~60Hz
Charging time:	Approx.40mins
Oil capacity:	Approx.60ml
Stroke:	20mm
Service interval:	10000cycles
Voltage of battery:	DC 18V,2.0Ah
Ambient temperature:	-10°C~40°C
Weight:	For axial press Pex and Multi-layer pipe 1.94kgs(tool with battery)

#### Accessories:

Connecting jaws(optional):	6.35、9.52、12.7、15.88、19.05、 22.2、25.4、28.6mm (Integral type)
Battery:	2 pcs
Charger:	1 pc
Sealing ring of cylinder:	1 set
Sealing ring of safety valve:	1 set



## PZ-4523

### Battery Powered Axial Press Tool

For axial press air conditioner pipe  
Be used in air conditioner,heating,refrigeration system

#### Specifications

Rated pressure:	45kN
Stroke:	23mm
Connecting range:	Φ6.35-38.1mm copper pipe
Oil capacity:	Approx.60ml
Ambient temperature:	-10°C~40°C
Service interval:	10000cycles
Voltage of battery:	DC 18V,2.0Ah
Charging voltage:	AC 100V~240V ;50~60Hz
Charging time:	Approx.40mins
Weight:	4.16kgs(tool with battery)
Tool size:	380x155x75mm

#### Accessories:

Connecting jaws(optional):	6.35, 9.52, 12.7, 15.88, 19.05, 22.2, 25.4, 28.6, 31.8, 34.9, 38.1mm
Battery:	2 pcs
Charger:	1 pc
Sealing ring of cylinder:	1 set
Sealing ring of safety valve:	1 set



- The dies for the tool is optional, there are split type and integral type:
- Split type: 6.35, 9.52, 12.7, 15.88, 19.05, 22.2, 25.4mm
- Integral type: 28.6, 31.8, 34.9, 38.1mm



**HT-1240** Hand-operated Hydraulic Axial Press Tool

- Sliding connections for PEX and Multi-layer composite pipe
- Two stage hydraulic system with fast feed

Technical data	
Connecting/Expanding range:	φ16-32mm
Cutting range:	Max φ40mm
Stroke:	38mm
Oil capacity:	48ml
Package:	Plastic box
Accessories:	
Connecting jaws:	φ16-20mm, φ25-32mm
Expanding dies:	Pex pipe :φ16x2.2-φ20x2.8、φ25x3.5、φ32x4.4 PAP pipe(optional) :φ16.2x2.6、φ20x2.9、φ25x3.7、φ32x4.7

**Kit includes:**  
One axial press tool and expand tool,cutter  
Two pairs connecting jaws,three expanding jaws and carrying case



**FT-1240** Manual Axial Press Tool

- Sliding connections for PEX and Multi-layer composite pipe
- Connecting jaws made of alloy steel with precision casting, ratchet drive makes durable and reliable
- Connecting jaws built-in anti-attribution bushing makes easy sliding
- Expander handle made of high-strength aluminum alloy with precision forging,light and handy

Technical data	
Connecting/Expanding range:	Φ16-32mm
Cutting range:	Max Φ40mm
Weight:	5.2kgs
Stroke:	40mm
Package:	Plastic box
Accessories	
Connecting jaws:	φ16-20mm, φ25-32mm
Expanding dies:	Pex pipe :φ16x2.2-φ20x2.8、φ25x3.5、φ32x4.4 PAP pipe(optional) :φ16.2x2.6、φ20x2.9、φ25x3.7、φ32x4.7

**Kit includes:**  
One axial press tool and expand tool,cutter  
Two pairs connecting jaws,three expanding jaws and carrying case



**TE-1632** Manual Expand Tool

- Expander handle made of high-strength aluminum alloy with precision forging,light and handy.

Technical data	
Expanding range:	Φ16-32mm
Expanding dies:	Φ16-20,25,32mm
Length:	395mm
Weight:	1.33kgs

**PE-1632** Manual Expand Tool

- Expander handle made of high-strength aluminum alloy with precision forging,light and handy.

Technical data	
Expanding range:	Φ16-32mm
Expanding dies:	Φ16,20,25,32mm
Length:	395mm
Weight:	2.12kgs

**JT-1632** Manual Press Tool

- 360° rotating head
- Fast Change of crimping die without readjustment by specialfixing system
- With telescope handles, effort-saving

Technical data	
Press force:	40kN
Stroke:	16mm
Package:	Plastic box
Accessories	
Press die for V type:	Φ12,15,18,22,28mm
Press die for U type:	Φ16,20,25,32mm
Press die for TH type:	Φ16,20,26,32mm

Note:The accessories type used at optional



**JT-1626** Manual Press Tool

- Ratchet locking type,ensure accurate reliability press
- Quick-change mounting for simple dies changing
- Antiskid handle structure designed make the press process more comfortable

Technical data	
Weight:	2.1kgs
Length:	508mm
Package:	Plastic box
Accessories:	
Press die for U type:	Φ16,20,25mm
Press die for TH type:	Φ16,20,26mm

Note:The accessories type used at optional

**FT-1225** Manual Axial Press Tool

- Easy changeable sliding jaws
- Smart tool body,easy one handed operation

Technical data	
Connecting range:	Φ12-25mm
Expanding range:	Φ12-20mm
Cutting range:	Max Φ42mm
Stroke:	80mm
Accessories	
Jaws:	Φ12,16,20mm

PATENT NO.:ZL 2004 3 0035588.1

**ETM-20/ETM-32** Manual Expand Tool

Made of steel with precision casting

Technical data	
ETM-20 Expanding range:	Φ12-20mm
ETM-20 Length:	160mm
ETM-20 Weight:	0.33kgs
ETM-32 Expanding range:	Φ16-32mm
ETM-32 Length:	180mm
ETM-32 Weight:	0.58kgs



JT-1620 Manual Press Tool	
<b>Technical data</b>	
Weight:	1.7kgs
Length:	485mm
Package:	Plastic box
<b>Accessories:</b>	
Press die for U type:	Φ16,20mm
Press die for TH type:	Φ16,20mm

FT-15B/18B/24B PEX Pipe Press Tool			
<b>Technical data</b>			
Model	FT-15B	FT-18B	FT-24B
Press range:	Φ15(3/8")	Φ18(1/2")	Φ24(3/4")
Length:	310mm	310mm	310mm
Weight:	1.30kgs	1.30kgs	1.30kgs
Package:	Paper box	Paper box	Paper box

ZT-1824 PEX Pipe Press Tool	
<b>Technical data</b>	
Press range:	Φ18(1/2")-Φ24(3/4")
Length:	400mm
Weight:	1.20kgs
Package:	Paper box

FT-15/18/24 PEX Pipe Press Tool			
<b>Technical data</b>			
Model	FT-15	FT-18	FT-24
Press range:	Φ15(3/8")	Φ18(1/2")	Φ24(3/4")
Length:	275mm	275mm	300mm
Weight:	0.9kgs	0.9kgs	1.0kgs
Package:	Paper box	Paper box	Paper box

ZT-15/18/24 PEX Pipe Press Tool			
<b>Technical data</b>			
Model	ZT-15	ZT-18	ZT-24
Press range:	Φ15(3/8")	Φ18(1/2")	Φ24(3/4")
Length:	330mm	330mm	370mm
Weight:	1.0kgs	1.0kgs	1.0kgs
Package:	Paper box	Paper box	Paper box

U-25/32 PVC Pipe Cutter		
<b>Technical data</b>		
Model:	U-25	U-32
Max cutting range:	Φ25mm	Φ32mm
Length:	200mm	210mm
Weight:	0.14kgs	0.15kgs

Note: The accessories type used at optional



FT-1824 PEX Pipe Press Tool	
<ul style="list-style-type: none"> <li>Stamping handle with heat treatment. Intensity, durable and reliable</li> <li>Comfortable skid resistance cover</li> <li>Alloy steel forged clamp arm is processed by CNC and strengthened by heat treatment, sturdy and durable</li> </ul>	
<b>Technical data</b>	
Press range:	Φ18(1/2")-Φ24(3/4")
Length:	290mm
Weight:	0.95kgs
Package:	Paper box

FT-1824B PEX Pipe Press Tool	
<ul style="list-style-type: none"> <li>Stamping handle with heat treatment. Intensity, durable and reliable</li> <li>Comfortable skid resistance cover</li> <li>Alloy steel forged clamp arm is processed by CNC and strengthened by heat treatment, sturdy and durable</li> </ul>	
<b>Technical data</b>	
Press range:	Φ18(1/2")-Φ24(3/4")
Length:	400mm
Weight:	1.60kgs
Package:	Paper box

FT-1530 PEX Pipe Press Tool	
<ul style="list-style-type: none"> <li>Mechanical crimping tool for connecting fitting with pipe</li> <li>Crimp XPAP, PEX with fittings up to Φ30mm</li> </ul>	
<b>Technical data</b>	
Press range:	Φ15mm(3/8")-30mm(1")
Press dies:	Φ15mm(3/8"), 18mm(1/2"), 20mm(5/8"), 24mm(3/4"), 30mm(1")
Length:	400mm
Weight:	1.6kgs
Package:	Plastic box

U-42 PVC Pipe Cutter	
<b>Technical data</b>	
Max cutting range:	Φ42mm
Length:	195mm
Weight:	0.26kgs

SSC-1530 PEX Pipe Cinch Tool	
<b>Technical data</b>	
Cinching range:	3/8", 1/2", 5/8", 3/4", 1"
Weight:	0.6kgs
Length:	278mm
Package:	Blister card

ST-1530 PEX Crimp Ring Removal Tool	
<b>Technical data</b>	
Removal range:	Max up to 1"
Weight:	0.3kgs
Length:	220mm
Package:	Blister card



**PS-1632A Deburring Tool**

Technical data	
Features:	For multilayer composite and Pex pipe up to $\Phi$ 32mm
Deburring range:	$\Phi$ 16,20,26,32mm

**PS-1632B Deburring Tool**

- Cutting device made of steel for long lifetime and with sharp cutting edge
- Large opening for removing pipe chips
- Anodic oxidation aluminium alloy sleeve is light and wear-resisting
- Hexagonal connector for changing different sizes easily, for handle, standard bit connectors or cordless screw driver



**Technical data**

Features:	For multilayer composite and Pex pipe up to $\Phi$ 32mm
Deburring range:	$\Phi$ 16,20, 26,32mm



**PS-40 , PS-50, PS-63 Deburring Tool**

Technical data			
Model	PS-40	PS-50	PS-63
Deburring range:	$\Phi$ 40mm	$\Phi$ 50mm	$\Phi$ 63mm



**TB-22 Hydraulic Bending Tool**

- For accurate one handed bending up to 90°, suit for 10-22mm(1/4"-7/8") thickness below 1.0mm copper pipe
- Ideal in confined spaces
- Quick release and resetting of bending formers
- Bending formers easily changed
- Optimal bending results

**Technical data**

Former in inch		Former in metric	
Size	Weight	Size	Weight
1/4 "	0.093kgs	10mm	0.087kgs
5/16 "	0.091kgs	12mm	0.113kgs
3/8 "	0.08kgs	14mm	0.146kgs
1/2 "	0.128kgs	15mm	0.141kgs
5/8 "	0.153kgs	16mm	0.14kgs
3/4 "	0.194kgs	18mm	0.193kgs
7/8 "	0.222kgs	20mm	0.18kgs
		22mm	0.201kgs



**TBJ-32 Manual Bending Tool**

- For accurate one handed bending up to 90°, suit for copper and XPAP, PEX pipe
- Ideal in confined spaces
- Quick release and resetting of bending formers
- Bending formers easily changed
- Optimal bending results

**Technical data**

Former in metric		Copper pipe		XPAP, PEX pipe	
Size	Weight				
16mm	0.14kgs	✓		✓	
20mm	0.18kgs	✓		✓	
26mm	0.24kgs	×		✓	
32mm	0.42kgs	×		✓	



**TBJ-22 Manual Bending Tool**

- For accurate one handed bending up to 90°, suit for 10-22mm(1/4"-7/8") thickness below 1.5mm copper pipe
- Ideal in confined spaces
- Quick release and resetting of bending formers
- Bending formers easily changed
- Optimal bending results

**Technical data**

Former in inch		Former in metric	
Size	Weight	Size	Weight
1/4 "	0.093kgs	10mm	0.087kgs
5/16 "	0.091kgs	12mm	0.113kgs
3/8 "	0.08kgs	14mm	0.146kgs
1/2 "	0.128kgs	15mm	0.141kgs
5/8 "	0.153kgs	16mm	0.14kgs
3/4 "	0.194kgs	18mm	0.193kgs
7/8 "	0.222kgs	20mm	0.18kgs
		22mm	0.201kgs



## ADVANTAGE OF ZUPPER PRESS JAW

### Connecting Plate

- Precision stamping
- Security design

### Serial NO.

- Tracking numbers easier to do after-sales service



### Precision Forged Jaws

- Made by multi-axis CNC machine
- High strength, sturdy and durable

### Special heat treatment process

- Inspection control program to ensure long span life

ZUPPER TOOL have a wealth of design and practical experience, can provide customers with differentiated solutions according to customer needs, and to offer customers with pipe press technical support.

## SUITABLE PRESS TOOL

- Compact series press jaws, suit for output 19kN press tool:  
PZ-1930, BZ-1930, SL-1930, MP-1930, BLM-1930, etc
- Another Compact series press jaws, suit for output 24kN press tool:  
PZ-2430, SL-2430, BLM-2430
- Standard series press jaws, suit for output 32kN press tool:  
PZ-1550, CZ-1550, EB-1550, ED-1550, BZ-1550, HH-1550, HZ-1550, FHT-3240, PZ-3240, etc
- Thicken series press jaws, suit for output 50kN press tool:  
ED-5050, HH-5050, PZ-5050, etc
- Big size press jaws, suit for output 80kN press tool:  
ED-60100, HH-60100, FHT-60100



Compact series press jaws

Standard series press jaws

Thicken series press jaws



Big size press jaws

Universal Jaw with interchangeable dies fit for PEX pipe  
Economic design for any need

Adaptor / Press Rings for 42-54mm

### Interchangeable dies

- 1) One universal jaw with different types of dies, with a high cost performance
- 2) Quick change mounting for replace the dies easily

**NOTE:** The economic design only for PEX or PAP pipe, not for stainless pipe and copper pipes.

## THE NEW FLEXIBILITY-ANGLE JAWS

Suit for narrow,angled installation areas which are difficult to access

### R8 Angle Jaw

Provide with differentiated solutions according to customers requirement

R8 M15, R8 M18, R8 M22, R8 M28, R8 M35  
R8 V15, R8 V18, R8 V22, R8 V28, R8 V35.....

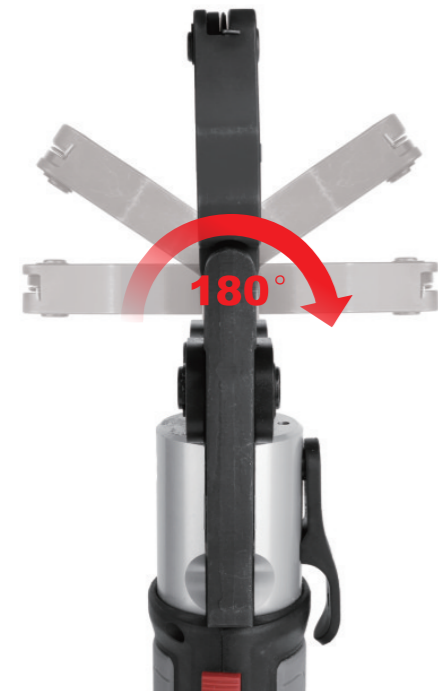

### R9 Angle Jaw

Provide with differentiated solutions according to customers requirement

R9 M15, R9 M18, R9 M22, R9 M28, R9 M35, R9 M42, R9 M54  
R9 V15, R9 V18, R9 V22, R9 V28, R9 V35, R9 V42, R9 V54  
13SR,20SR,25SR,30SR,40SR,50SR,60SR.....



### R9 Rotating Adaptor Jaw

R9-32[suit for PZ-3240,PZ-1550,CZ-1550,EB-1550, ED-1550, etc]



Standard Series Press Jaws & Press Rings		
DESCRIPTION	JAW SIZE	Weight (KGS)
PEX& MULTI-LAYER PIPE	TH16	2.05
	TH20	2.00
	TH25	2.05
	TH26	2.05
	TH32	2.10
	TH40	2.2
	TH50	1.9
	TH63	2.67

DESCRIPTION	JAW SIZE	Weight (KGS)
PEX& MULTI-LAYER PIPE	U16	1.95
	U20	2.05
	U25	2.00
	U32	2.15
	U40	2.20
	U50	2.8
	U63	2.47
	U75	2.6

DESCRIPTION	JAW SIZE	Weight (KGS)
FOR STAINLESS STEEL PIPE	SV13	2.01
	SV20	2.07
	SV25	2.03
	SV30	-

Standard Series Press Jaws & Press Rings		
DESCRIPTION	JAW SIZE	Weight (KGS)
FOR COPPER PIPE	VAU15	2.00
	VAU20	2.06
	VAU25	2.04
	VAU32	2.09
	VAU40	1.48
	VAU50	1.75

Standard Series Press Jaws		
DESCRIPTION	JAW SIZE	Weight (KGS)
FOR COPPER PIPE	VUS1/2"	2.00
	VUS3/4"	2.10
	VUS1"	2.05
	VUS1-1/4"	2.08
	VUS1-1/2"	2.70
	VUS2"	3.90

DESCRIPTION	JAW SIZE	Weight (KGS)
FOR STAINLESS STEEL /COPPER PIPE	M12	2.00
	M15	2.00
	M18	1.95
	M22	2.00
	M28	2.00
	M35	2.05
	M42	1.35
	M54	1.60

Special jaws can be made according to your requirements.

Special jaws can be made according to your requirements.

### Standard Series Press Jaws

DESCRIPTION	JAW SIZE	Weight (KGS)	
FOR STAINLESS STEEL /COPPER PIPE	V12	2.02	
	V15	1.95	
	V18	2.10	
	V22	2.05	
	V28	2.00	
	V35	2.05	
	V42	1.40	
	V54	1.63	

DESCRIPTION	JAW SIZE	Weight (KGS)	
FOR STAINLESS STEEL /COPPER PIPE	SDR13	2.0	
	SDR20	2.1	
	SDR25	2.05	
	SDR30	1.25	
	SDR40	1.45	
	SDR50	1.6	
	SDR60	1.9	

### Compact Series Press Jaws

DESCRIPTION	JAW SIZE	Weight (KGS)	
PEX& MULTI-LAYER PIPE	TH16	1.27	
	TH20	1.33	
	TH25	1.41	
	TH26	1.35	
	TH32	1.40	

### Compact Series Press Jaws

DESCRIPTION	JAW SIZE	Weight (KGS)	
PEX& MULTI-LAYER PIPE	U16	1.20	
	U20	1.29	
	U25	1.30	
	U32	1.50	

DESCRIPTION	JAW SIZE	Weight (KGS)	
FOR STAINLESS STEEL /COPPER PIPE	M12	1.23	
	M15	1.30	
	M18	1.29	
	M22	1.37	
	M28	1.39	
	M35	1.40	

DESCRIPTION	JAW SIZE	Weight (KGS)	
FOR STAINLESS STEEL /COPPER PIPE	V12	1.23	
	V15	1.23	
	V18	1.29	
	V22	1.38	
	V28	1.47	

DESCRIPTION	JAW SIZE	Weight (KGS)	
FOR STAINLESS STEEL PIPE	SV13	1.23	
	SV20	1.27	
	SV25	1.34	
	SV30	-	

DESCRIPTION	JAW SIZE	Weight (KGS)	
FOR COPPER PIPE	VAU15	1.23	
	VAU20	1.28	
	VAU25	1.35	
	VAU32	1.49	

Special jaws can be made according to your requirements.

Special jaws can be made according to your requirements.

### Compact Series Press Jaws

DESCRIPTION	JAW SIZE	Weight (KGS)	
FOR COPPER PIPE	VUS1/2"	1.23	
	VUS3/4"	1.26	
	VUS1"	1.48	

### Big size Press Jaws

DESCRIPTION	JAW SIZE	Weight (KGS)	
FOR STAINLESS STEEL PIPE	S63.5	3.05	
	S76.1	3.7	
	S88.9	4.1	
	S101.6	5.5	
	S108	5.7	
FOR STAINLESS STEEL PIPE	M67	3.5	
	M76.1	3.9	
	M88.9	4.35	
	M108	5.7	
FOR STAINLESS STEEL PIPE	SDR80	4.4	
	SDR100	5.6	

---

---

---

---

---

---

---

---

---

---

---

---

---

---

---

---

---

---

---

---

---

---

---

---

---

---

---

Special jaws can be made according to your requirements.